

IKA

HELAGO® CZ

designed for scientists

EN



PRODUCT OVERVIEW 2020



One
Hundred
Ten
1910 – 2020
IKA

OUR BAR IS SET HIGHER

/// Welcome to the IKA World of Laboratory & Analytical Technology 2020

According to a study by the University of St. Gallen, IKA can officially refer to itself as “global market leader”. This distinction confirms our continuous striving for both the best and the smartest technology. Why? Because you and we are just people, in the end. We are all happy if our day-to-day work not only functions well, but is also fun. IKA is setting the bar ever higher and always challenges itself.

While you are holding the 2020 product overview in your hands, we are celebrating our 110th anniversary. And at the very start of the year we received yet another prize – the German Design Award for our 18-piece IKA PETTE range. Yes, even the pipette is getting smarter. Give it a try!



Electrochemistry	12	ElectraSyn 2.0
	18	Screening System
Mixing	20	Magnetic Stirrers
	32	Overhead Stirrers
	44	Shakers
Crushing	56	Dispersers
	66	Mills
Vacuum Technology	78	Vacuum Pumps
	81	Vacuum Controller
Measuring Viscosity	72	Measuring Stirrers
	74	Viscometers
Heating, Cooling & Tempering	82	Temperature Control
	92	Dry Block Heaters
	94	Heating Baths
	98	Drying Ovens
Separation	100	Rotary Evaporators
	106	Centrifuges
Liquid Handling	108	Pipettes
Reactor Systems	112	Laboratory Reactors
	118	magic PLANT
	119	Photo Bioreactors
Controlling / Measuring	120	labworldsoft® 6
	121	CalWin 6040
Calorimetry	122	Calorimeters
	125	Decomposition Systems
Accessories	130	Mechanical & Electronic Accessories
IKA Packages	132	Packages

/// HIGHLIGHTS 2020

Which challenge do you need solved? Our 2020 innovative product highlights allow particularly simple, reliable and safe stirring, mixing, distilling, milling, and temperature control.

We would be happy to advise you as to which devices from this broad and complex product range would suit your applications.



/// Shakers

Shaking is one of IKA's core competencies. With IKA Matrix, there is a new powerful product family of thermoshakers available. Mixing, heating, cooling, or all at once? No limits are set with IKA Matrix.

/// Viscometers

Thanks to the all new ROTAVISC series, you can now process your samples with the tried-and-tested IKA laboratory device structure right up to the viscosity measurement stage.



/// Pipettes

An ergonomic feel combined with uncompromising precise performance: the IKA single fix and vario pipettes can be used for many applications in the modern laboratory.



/// Centrifuges

Separating substances at medium rotational speeds: IKA G-L is the ideal midi centrifuge for all types of separation processes such as those found in molecular biology.



/// Measuring Stirrers

IKA STARVISC 200-2.5 control, the new measuring stirrer, is a globally unique system: it simultaneously measures and displays viscosity during product development.





/// Mills

With MultiDrive we present the globally unique all-rounder in coarse and fine crushing. Thanks to the large number of vessels, the device handles a wide variety of crushing tasks, for hard, soft or fibrous samples.

/// Calorimeters

The champion of modern calorimetry has been developed even further. The new C 6000 has an intuitive touch screen with unique user guidance. Its high level of automation simplifies everyday work and enables high sample throughput.

/// Drying Ovens

The models in the IKA Oven 125 series have the largest drying chambers in their class and are powerful devices for temperature regulation, drying, ageing and heating tasks.

/// Overhead Stirrers

A reduced design and the focus on the most essential aspects make the new IKA NANO-, MICRO- and MINISTAR stirrers reliable laboratory companions.



/// Magnetic Stirrers

More power or more individualization? We offer both: The new RCT 5 digital with 850 W is now even more powerful and IKA myPlate combines excellent technical features with the option of creative individualization.



/// Dispersers

T 25 easy clean high-performance disperser is globally without equal. For the first time, it is possible to clean its tool without dismantling, because the rotor can be extended in one simple step.



/// INTEGRATED SAFETY – THE IKA SAFETY CONCEPT

Safety has the highest priority at IKA. In order to protect users in the laboratory, our products have CE certifications and fulfill the requirements described in common standards such as DIN IEC EN 610410-1, DIN IEC EN 61010-2-010, DIN EN IEC 61010-2-051 and DIN IEC EN 61326-1.

Whether heat or chemicals are involved, our Integrated Safety Concept protects the sample, the laboratory and the user and provides the basis for the success of your experiments.



Independent regulation circuits

On many devices there is more than one temperature to monitor. Independent safety circuits ensure that a critical temperature cannot be exceeded under any circumstances – even if the temperature sensor in the medium or in the heating element is defective or fails completely.

Wireless remote control

A wireless remote control (WiCo) permits operation of your laboratory equipment from a safe distance. For example, the control versions of IKA laboratory reactors and thermostats are equipped with a Wireless Controller, or WiCo for short.

Safety shutoff

Unintentional operation cannot continue if the vessel or cover have been removed. For this reason, IKA Integrated Safety contains safety shutoffs, for example on laboratory reactors or mills. The IKA rotary evaporators automatically lift the evaporation flask out of the heating bath in the event of a power failure.

Temperature monitoring

Maximum temperatures, safety temperatures and temperature warnings guarantee safety in the laboratory. Integrated Safety ensures that flashpoints are not reached. Safety temperatures are set manually using a small tool with each laboratory process. And, even if the magnetic stirrer and heating function is switched off, a warning is issued as long as the heating plate measures in excess of 50 °C.



“Hot spot” monitoring

The hottest area of a magnetic stirrer – the so-called “hot spot” – is the set-up plate. Alongside the vessel and its contents, this is itself specifically monitored thanks to Integrated Safety. This means that glass vessels will not break following appropriate setting and the media or reagents will not boil over.

Locking function

Locking functions on our magnetic stirrers, for example, prevent inadvertent changes to the temperature and speed values or changes to settings by unauthorized persons.



Sturdy housing

Chemically-resistant housings and displays, made from hardened, shatterproof glass are to be found wherever dangerous substances or heat are involved, such as in our latest generation of magnetic stirrers.

/// AWARD-WINNING LABORATORY EQUIPMENT

Be it for the strength of its innovation, the quality of its design, its global sense of responsibility or its commitment to the region – IKA regularly receives awards for its outstanding performance. Entrepreneurial courage, dynamic processes and communication-readiness justify these successes. They show us that commitment and perseverance always pay dividends!



German Design Award 2020 for IKA PETTE

The new IKA PETTE fix and vario pipettes, available in a total of 18 different models, have been awarded the German Design Award 2020 for outstanding design quality. The design committee recognized the laboratory classic in the category "Excellent Product Design – Industry".

The ingenious ergonomic design of the new PETTE not only looks good, it also proves to be effective, particularly where frequent pipetting is required in the laboratory. Three interchangeable ergonomic grips are included with the PETTE, because each hand is shaped differently. In addition, the large mechanical volume display contributes to the specialties of the design. It is easy to read, even when pipetting.



Innovative power and economic success

Research carried out by the University of St. Gallen have been placing IKA in the global market leader index for years. Our company is also entitled to display the WirtschaftsWoche seal once again in 2020. IKA has also been honored for its innovativeness time and again. We have been included among the most innovative companies in Germany already three times, as honored by the TOP 100 panel and mentor Ranga Yogeshwar. In 2015, IKA even managed to jump up to 2nd place in the class of companies with more than 250 employees. At theACHEMA Innovation Awards in Frankfurt am Main, IKA shortlisted for the ElectraSyn 2.0, the pioneering product in electrochemistry.



Design strength and user-friendliness

The fact that an appealing and convenient design plays a central role at IKA has also been regularly honored. Be it the Red Dot Design Award or the German Design Award, IKA products always impress with their particularly successful user-friendly design. The coveted Red Dot Award was received in 2013 for the Tube Mill control batch mill and the LR 1000 laboratory reactor, and, in 2018, for the world's first ElectraSyn 2.0, a device for electrochemical synthesis. The UTDD control disperser was awarded a "special mention" by the German Design Council in 2014. Almost every year since then, IKA has been honored with design awards. In 2018, IKA T 25 easy clean, a high-performance disperser, received the German Design Award as a technical world innovation.



Entrepreneurial responsibility

In 2013, the Oskar Patzelt Foundation awarded IKA the "Grand Prix of Medium-Sized Companies": In the regional competition Baden-Wuerttemberg, IKA came first place in the Industry category. In the same year, we received the Medium-Sized Company prize for social responsibility in Baden-Wuerttemberg, for our particular involvement with the aid project HANDS FOR CHILDREN, which we initiated.

In a unique endeavor, IKA owner René Stiegelmann has partnered up with Professor Phil S. Baran of the world-renowned Scripps Research Institute in La Jolla, California (USA). Over three years, engineers and chemists have worked hand in hand to develop a product combining two divisions of chemistry communities: the Electrochemical and the mainstream Synthetic Organic Chemistry Communities that traditionally don't have much in common.

ELECTRASYN 2.0 PACKAGE

/// Your chemistry has potential

Three devices
in one



ElectraSyn 2.0 essentially combines three products in one and will facilitate the mass adoption of electrochemistry for preparative organic synthesis: a potentiostat, an analytical device and a magnetic stirrer. It is a compact, user friendly and cost effective platform for organic chemists to explore electrochemistry.

The ElectraSyn 2.0 Ready-To-Go package includes all that is required to for your first experiment: Potentiostat, including a single 10 ml vial, vial holder, stir plate (aluminum), and a set of electrodes (graphite).

ElectraSyn 2.0 Package

EUR 2.389,00

Ident. No. 0020008980

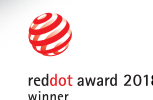

- > ElectraSyn 2.0 base unit
- + vial holder
- + single vial, 10 ml, complete
- + 2 electrodes (graphite)
- + stir plate (aluminum)
- + stir bar

Ready-To-Go
package

ElectraSyn 2.0 pro Package

EUR 2.808,00

Ident. No. 0040003261



- > ElectraSyn 2.0 base unit
- + vial holder
- + single vial, 10 ml, complete
- + 2 electrodes (graphite)
- + stir plate (aluminum)
- + stir bar
- + set of CV electrodes:
 - + CV glassy carbon
 - + CV platinum
 - + reference electrode Ag | AgCl

TECHNICAL DATA	ELECTRASYN 2.0 PACKAGE PRO PACKAGE
Stirring quantity max. (H ₂ O)	0,1 l
Speed range	50 – 1500 rpm
Voltage output	30 10 V
Current output	100 mA
Display	TFT
Permissible ambient temperature	5 – 50 °C
Dimensions (W × H × D)	130 × 150 × 250 mm
Protection class according to DIN EN 60529	IP 40

ELECTRASYN 2.0 APP

Monitor reactions as well as CV graphs, transmit experiments, receive software update notifications, access the online IKA store for ordering supplies, and receive latest video tutorial updates. ElectraSyn 2.0 is a device that improves over time through regular software updates available through a simple app. You can also use the app to configure your ElectraSyn 2.0 by shopping available devices and accessories.





Carousel complete



GOGO Module



e-Hive

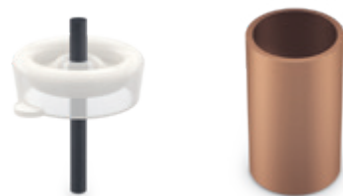

Graphite electrode inner

Copper electrode outer

Product	Description	Ident. No.	Price
ATTACHMENTS			
Carousel	Attachment for multi measurements	0020017512	EUR 1.999,00
Carousel complete	Attachment for multi measurements, incl. glass vials	0040005427	EUR 2.799,00
e-Hive	Screening platform with a maximum of 24 reactions	0040004945	EUR 2.498,00
GOGO Module	Universal extension for ElectraSyn 2.0	0040006052	EUR 549,00
Pro-Seal	Vial cap for gas exchange	0040007151	EUR 390,00
Pro-Divide	Reaction cell for divided electrochemistry	0040006482	EUR 597,00
Calibration cap	Calibration cap for ElectraSyn 2.0	0040007388	EUR 187,00
ELECTRODES FOR E-HIVE			
Copper electrode inner	Anode copper (24 pcs.)	0040007427	EUR 312,00
Graphite electrode inner	Anode graphite (24 pcs.)	0040007430	EUR 124,00
Stainless electrode inner	Anode stainless steel (24 pcs.)	0040007429	EUR 248,00
Copper electrode outer	Cathode copper (24 pcs.)	0040007436	EUR 544,00
Graphite electrode outer	Cathode graphite (24 pcs.)	0040007438	EUR 430,00
Stainless electrode outer	Cathode stainless steel (24 pcs.)	0040007443	EUR 153,00



Glass vial 5 ml

Glass vial complete 10 ml



ElectraSyn 2.0 Complete Starter Kit



Microvial 1 ml



ElectraSyn 2.0 Micro Starter Kit complete

Product	Description	Ident. No.	Price
VIALS / ELECTRODES			
Glass vial complete 5 ml	Glass vial 5 ml incl. lid, glass and magnetic bar	0040003171	EUR 112,00
Glass vial complete 10 ml	Glass vial 10 ml incl. lid, glass and magnetic bar	0040003170	EUR 104,00
Glass vial complete 20 ml	Glass vial 20 ml incl. lid, glass and magnetic bar	0040003168	EUR 105,00
Glass vials 5 ml	Glass vial 5 ml, set of 10	0040003327	EUR 257,00
Glass vials 10 ml	Glass vial 10 ml, set of 10	0040003325	EUR 175,00
Glass vials 20 ml	Glass vial 20 ml, set of 10	0040003324	EUR 188,00
ElectraSyn 2.0 Electrode Starter Kit	Kit of 9 electrodes, set of 12 (glassy carbon, set of 2 only)	0020017204	EUR 1.345,00
ElectraSyn 2.0 Complete Vial Kit	Kit of 5 ml, 10 ml and 20 ml vials complete, 10 spare vials of each volume	0010003810	EUR 945,00
ElectraSyn 2.0 vials only	Kit of 10 x 5 ml, 10 x 10 ml, 10 x 20 ml vials	0010003811	EUR 622,00
ElectraSyn 2.0 Complete Starter Kit	Kit of 5 ml, 10 ml, 20 ml vials complete; 10 spare vials of each volume; 9 electrodes, set of 12 (glassy carbon, set of 2 only)	0040004013	EUR 2.290,00
Electrode CV Package	Kit of electrodes (CV glassy carbon, CV platinum, reference electrode)	0040002864	EUR 419,00
MICROVIALS / MICROELECTRODES			
Microvial 1 ml	Glass vial 1 ml incl. lid, glass and magnetic bar	0040003294	EUR 140,00
Microvial 2 ml	Glass vial 2 ml incl. lid, glass and magnetic bar	0040003295	EUR 140,00
Micro glass vials 1 ml	Glass vial 1 ml, set of 10	0020017207	EUR 367,00
Micro glass vials 2 ml	Glass vial 2 ml, set of 10	0020017206	EUR 363,00
ElectraSyn 2.0 Micro electrode Starter Kit	Kit of 8 electrodes, set of 12 (glassy carbon, set of 2 only)	0040004016	EUR 1.977,00
ElectraSyn 2.0 microvials only	Kit 10 x 1 ml, 10 x 2 ml vials	0040004103	EUR 731,00
ElectraSyn 2.0 Microvial Kit complete	Kit of 1 ml and 2 ml vials complete, 10 spare vials of each volume	0040004014	EUR 1.012,00
ElectraSyn 2.0 Micro Starter Kit complete	Kit of 1 ml and 2 ml vials complete; 10 spare vials of each volume; 8 electrodes, set of 12 (glassy carbon, set of 2 only)	0040004015	EUR 2.850,00

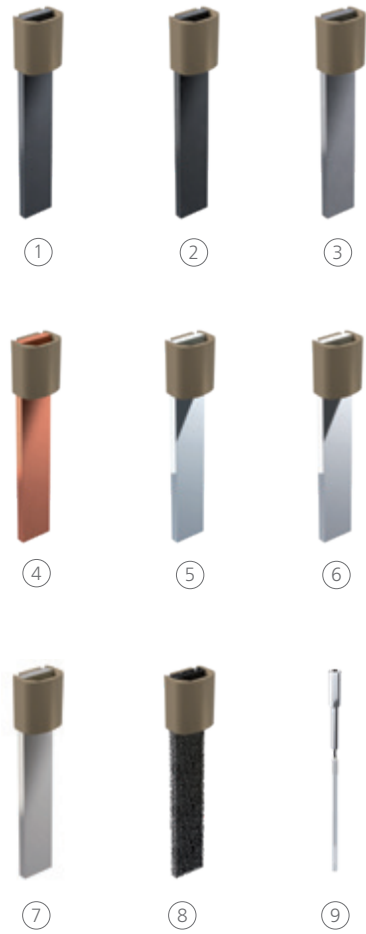

Product	Ident. No.	Price
ELECTRODES		
① Electrode graphite (12 pcs.)	0040002858	EUR 148,00
② Electrode glassy carbon (2 pcs.)	0040002842	EUR 111,00
Electrode lead bronze (2 pcs.)	0020016076	EUR 112,00
Electrode lead (12 pcs.)	0040002843	EUR 279,00
Electrode tungsten (2 pcs.)	0040002845	EUR 284,00
③ Electrode niobium (2 pcs.)	0040002846	EUR 105,00
④ Electrode copper (12 pcs.)	0040002847	EUR 77,00
Electrode magnesium (12 pcs.)	0040002848	EUR 272,00
Electrode titanium (12 pcs.)	0040002849	EUR 253,00
Electrode zinc (12 pcs.)	0040002850	EUR 253,00
Electrode stainless steel (12 pcs.)	0040002851	EUR 67,50
⑤ Electrode platinum plated (2 pcs.)	0040002852	EUR 99,00
Electrode platinum foil (2 pcs.)	0040005015	EUR 497,00
Electrode platinum on ceramics (2 pcs.)	0040006753	EUR 273,00
Electrode gold plated (2 pcs.)	0040002853	EUR 255,00
⑥ Electrode silver plated (2 pcs.)	0040002854	EUR 81,00
Electrode aluminum (12 pcs.)	0040003174	EUR 150,00
Electrode boron doped diamond (2 pcs.)	0040002856	EUR 442,00
Electrode tin (12 pcs.)	0040002857	EUR 266,00
⑦ Electrode nickel (12 pcs.)	0040002859	EUR 174,00
⑧ Electrode RVC foam (12 pcs.)	0040002860	EUR 251,00
Electrode nickel foam (12 pcs.)	0040002861	EUR 60,50
Electrode cobalt (2 pcs.)	0040003385	EUR 69,00
⑨ Electrode reference (1 pc.)	0040002865	EUR 181,00
Electrode CV glassy carbon (1 pc.)	0040002863	EUR 99,00

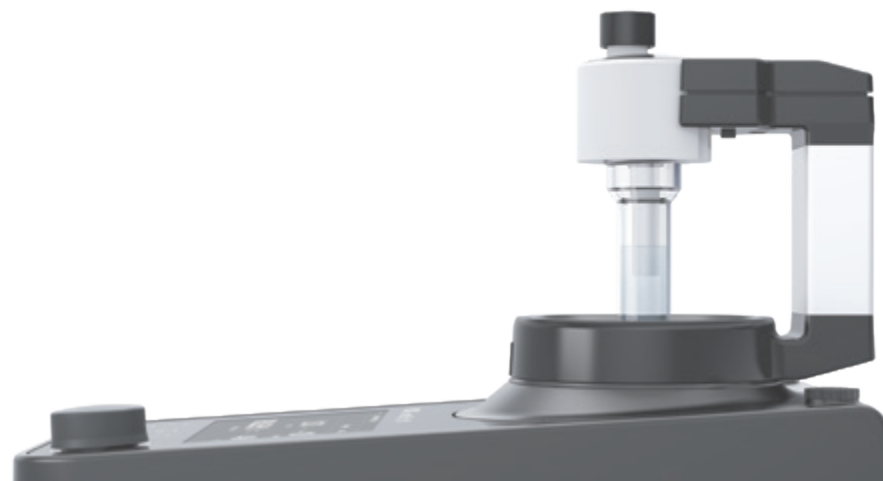

Product	Ident. No.	Price
MICROELECTRODES		
① Microelectrode aluminum (12 pcs.)	0040004029	EUR 50,00
Microelectrode boron-doped diamond (2 pcs.)	0040004036	EUR 625,00
② Microelectrode cobalt (2 pcs.)	0040004039	EUR 106,00
③ Microelectrode copper (12 pcs.)	0040004027	EUR 51,50
④ Microelectrode glassy carbon (2 pcs.)	0040004022	EUR 136,00
⑤ Microelectrode gold (2 pcs.)	0040004034	EUR 178,00
Microelectrode graphite SK-50 (12 pcs.)	0040004021	EUR 181,00
Microelectrode lead (12 pcs.)	0040004028	EUR 742,00
⑥ Microelectrode lead bronze (12 pcs.)	0040004030	EUR 192,00
Microelectrode magnesium (12 pcs.)	0040004025	EUR 434,00
Microelectrode nickel (12 pcs.)	0040004023	EUR 569,00
⑦ Microelectrode nickel foam (12 pcs.)	0040004101	EUR 78,00
⑧ Microelectrode niobium (2 pcs.)	0040004032	EUR 180,00
Microelectrode platinum (2 pcs.)	0040004038	EUR 89,50
Microelectrode silver (2 pcs.)	0040004035	EUR 60,50
Microelectrode stainless steel (12 pcs.)	0040004024	EUR 50,00
⑨ Microelectrode tin (12 pcs.)	0040004037	EUR 499,00
Microelectrode titanium (12 pcs.)	0040004033	EUR 434,00
Microelectrode tungsten (2 pcs.)	0040004031	EUR 80,00
Microelectrode zinc (12 pcs.)	0040004026	EUR 434,00
Microelectrode graphite V2100 (2 pcs.)	0040004040	EUR 117,00

Screening System Package (8 cells)

EUR 10.712,00

Ident. No. 0040003642



Screening System Package (6 cells)

EUR 11.639,00

Ident. No. 0040003631



TECHNICAL DATA

SCREENING SYSTEM PACKAGE (6 | 8 CELLS)

CONTINUOUSLY ADJUSTABLE POWER SUPPLY

Voltage output 0 – 32 V (± 1 mV)

Supply voltage 115 or 230 V
(50 Hz / 60 Hz)

MAGNETIC STIRRER

Speed range 0 – 1500 rpm

REACTION CELLS

Number of cells 6 or 8

Usable volume of undivided cell 8 ml

Usable volume of divided cell
(per chamber) 8 ml

Material PTFE

Divided cells Yes (reaction block with
6 cells)

Temperature control Yes (RT to 100 °C)

IKA Screening System

The IKA Screening System is perfectly suited for constant current electrosynthesis in “multibatch” mode. The combination of both divided and undivided batch cells enables you to quickly carry out research on multiple electroconversions at the same time. In addition, you can combine the system with other equipment in the laboratory.

Scope of delivery

- > Reaction block
- > Electrolysis cells
- > Power supply
- > IKA Plate (RCT digital) including PT 1000 temperature sensor
- > Cable set
- > Screw drive
- > Electrode graphite (16 pcs.)

Product	Ident. No.	Price
REACTION BLOCKS AND CELLS		
Reaction block with 6 divided cells	0020015936	EUR 1.999,00
Reaction block with 8 undivided cells	0020015943	EUR 1.099,00
Set of reaction cells (6 divided cells)	0040003647	EUR 1.799,00
Set of reaction cells (8 undivided cells)	0040003648	EUR 899,00
ELECTRODES		
Electrode 0.7 boron doped diamond (8 pcs.)	0040003932	EUR 3.897,00
Electrode 0.7 glassy carbon (16 pcs.)	0040003670	EUR 965,00
Electrode 0.7 graphite SK-50 (16 pcs.)	0040003954	EUR 165,00
Electrode 0.7 platinum (8 pcs.)	0040003678	EUR 591,00
Electrode 0.7 platinum on ceramics (2 pcs.)	0020023860	EUR 349,00
Electrode 0.7 gold (8 pcs.)	0040003934	EUR 373,00
Electrode 0.7 silver (8 pcs.)	0040003938	EUR 219,00
Electrode 0.7 nickel foam (16 pcs.)	0040003935	EUR 78,00
Electrode 0.7 graphite V2100 (16 pcs.)	0040003669	EUR 664,00
Electrode 0.7 nickel (16 pcs.)	0040003671	EUR 451,00
Electrode 0.7 stainless steel (8 pcs.)	0040003672	EUR 249,00
Electrode 0.7 lead (16 pcs.)	0040003673	EUR 491,00
Electrode 0.7 lead bronze (8 pcs.)	0040003674	EUR 323,00
Electrode 0.7 copper (8 pcs.)	0040003675	EUR 212,00
Electrode 0.7 magnesium (16 pcs.)	0040003677	EUR 451,00
Electrode 0.7 zinc (16 pcs.)	0040003680	EUR 425,00
Electrode 0.7 aluminium (16 pcs.)	0040003682	EUR 531,00
Electrode 0.7 cobalt (8 pcs.)	0040003933	EUR 306,00
Electrode 0.7 niobium (8 pcs.)	0040003936	EUR 279,00
Electrode 0.7 tin (8 pcs.)	0040003939	EUR 242,00
Electrode 0.7 titanium (8 pcs.)	0040003940	EUR 223,00
Electrode 0.7 tungsten (8 pcs.)	0040003941	EUR 323,00
Electrode 0.7 RVC (16 pcs.)	0040003937	EUR 390,00
Electrode 0.7 Sampler Kit incl. 7 x 2 electrodes*	0040004509	EUR 1.440,00
Electrode 0.7 Starter Kit incl. 9 x 1 electrode**	0040003646	EUR 4.427,00
Electrode 0.7 power supply	0040003604	EUR 3.999,00
SC 1.1 Cable (1 – 4)	0040003663	EUR 129,00
SC 1.2 Cable (5 – 8)	0020018590	EUR 129,00
SC 2.1 Crocodile clip for cable set	0040003630	EUR 25,00
labworldsoft® 6 Screening System	0020023690	EUR 650,00



Reaction block with 6 divided cells



Reaction block with 8 undivided cells



Divided cell



Undivided cell

*BDD, cobalt, gold, silver, niobium, tungsten, titanium

**graphite V2100, glassy carbon, magnesium, tin, nickel foam, nickel, lead, lead bronze, copper

We are of the opinion that you can make a laboratory classic even better: The magnetic stirrer was invented more than seven decades ago, but the world's best-selling stirrers have never been so strong, energy-efficient and durable as the modern IKA magnetic stirrers. We have developed devices for mixing tasks involving an extensive range of volumes and viscosities, with and without a heating function, and even for multiple syntheses in up to 36 vessels at the same time. One model even adapts to the optical preferences of its user.

RCT 5 DIGITAL

/// The most powerful generation of magnetic stirrers



The new RCT 5 digital magnetic stirrer, with a power rating of 850 watts, now offers significantly more power making it an ideal device for demanding stirring tasks up to 20 l.

INTELLIGENT SET-UP PLATE

The RCT 5 digital's set-up plate is made from white coated ceramic material, making it particularly resistant to chemicals. In addition, the shape is square, meaning that this modern magnetic stirrer provides even better space utilization for attachments and stirring vessels.

MULTIFUNCTIONAL MENU

Whether determining the direction of rotation, timer functions or sequence programming - the stirring process can be programmed individually from beginning to end. In this way, the reaction runs reliably and safely even without monitoring.

SIMPLE OPERATION

The intuitive multilingual IKA menu guide makes working with the RCT 5 digital pleasant and simple. It has a large LED display and can be controlled just as easily as any other IKA laboratory equipment.

IKA Plate (RCT digital)

EUR 875,00

Ident. No. 0025004601



RCT 5 digital

EUR 899,00

Ident. No. 0020002704

New:
850 W power



C-MAG HS 7 control

EUR 899,00

Ident. No. 0020002694



RET control-visc

EUR 1.399,00

Ident. No. 0005020000

Weighing
function



RET control-visc white

EUR 1.449,00

Ident. No. 0005030000



TECHNICAL DATA	IKA PLATE (RCT DIGITAL)	RCT 5 DIGITAL	C-MAG HS 7 CONTROL	RET CONTROL-VISC WHITE
Stirring quantity max. (H ₂ O)	20 l	20 l	20 l	20 l
Direction of rotation	right left	right left	right left	right
Speed range	50 – 1500 rpm	50 – 1500 rpm	50 – 1500 rpm	50 – 1700 rpm
Heat output	600 W	850 W	1000 W	600 W
Heating temperature range	RT + device self heating – 310 °C	RT + device self heating – 310 °C	RT + device self heating – 500 °C	RT + device self heating – 340 °C
Set-up plate material	Aluminium alloy	Aluminum with ceramic coating	Ceramic	Stainless steel 1.4301
Load capacity weighing function max.	–	–	–	5 kg
Set-up plate dimensions	Ø 135 mm	137 x 137 mm	180 x 180 mm	Ø 135 mm
Dimensions (W x H x D)	160 x 85 x 270 mm	160 x 85 x 270 mm	220 x 88 x 354 mm	160 x 85 x 270 mm
Protection class according to DIN EN 60529	IP 42	IP 42	IP 21	IP 42

① C-MAG HS 4 digital

EUR 640,00
Ident. No. 0004240200

② C-MAG HS 7 digital

EUR 749,00
Ident. No. 0003487000

③ C-MAG HS 10 digital

EUR 899,00
Ident. No. 0004240400



① C-MAG HS 4

EUR 513,00
Ident. No. 0003581000

② C-MAG HS 7

EUR 565,00
Ident. No. 0003581200

③ C-MAG HS 10

EUR 771,00
Ident. No. 0003581400



① RH basic

EUR 513,00
Ident. No. 0005019700

② RH basic white

EUR 616,00
Ident. No. 0005029700

③ RH digital

EUR 616,00
Ident. No. 0005019800

④ RH digital white

EUR 719,00
Ident. No. 0004678000



① RT 5

EUR 2.359,00
Ident. No. 0003690600

② RT 10

EUR 3.088,00
Ident. No. 0003691100

③ RT 15

EUR 3.912,00
Ident. No. 0003692600

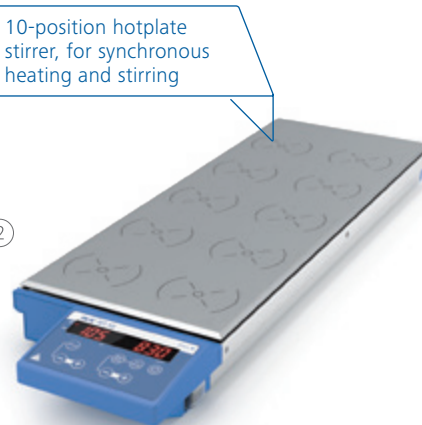

10-position hotplate stirrer, for synchronous heating and stirring

TECHNICAL DATA	C-MAG HS 4 7 10 DIGITAL	C-MAG HS 4 7 10	RH BASIC BASIC WHITE RH DIGITAL DIGITAL WHITE	RT 5 RT 10 RT 15
	Stirring quantity max. (H ₂ O)	5 l 10 l 15 l	5 l 10 l 15 l	15 l
Speed range	100 – 1500 rpm	100 – 1500 rpm	100 – 2000 rpm	0 – 1000 rpm
Heat output	250 W 1000 W 1500 W	250 W 1000 W 1500 W	600 W	175 W 375 W 580 W
Heating temperature	50 – 500 °C	50 – 500 °C	50 – 320 °C	Room temp. °C – 120 °C
Set-up plate material	Ceramic	Ceramic	Stainless steel 1.4301	Aluminium alloy
Connection for ext. temperature sensor	PT 1000	– ETS-D5 ETS-D5	ETS-D5	–
Dimensions (W × H × D)	150 × 105 × 260 mm 215 × 105 × 330 mm 300 × 105 × 415 mm	150 × 105 × 260 mm 220 × 105 × 335 mm 300 × 105 × 415 mm	160 × 100 × 250 mm	120 × 60 × 610 mm 190 × 60 × 610 mm 280 × 60 × 610 mm
Protection class according to DIN EN 60529	IP 21	IP 21	IP 21	IP 40

RET basic

EUR 1.131,00
Ident. No. 0003622000



RCT basic

EUR 749,00
Ident. No. 0003810000

BESTSELLER



RCT BASIC
/// Integrated safety



RCT basic fulfills, in all areas, the required safety regulations for laboratory equipment. The device is monitoring all safety relevant components and therefore is suitable for unsupervised operation. Safety is guaranteed in the event of malfunctions. Further safety features are an adjustable safety circuit, hot top indicator, precise temperature control and two independent control circuits.

TECHNICAL DATA	RET BASIC	RCT BASIC
Stirring quantity max. (H ₂ O)	20 l	20 l
Direction of rotation	Right	Right
Speed range	50 – 1700 rpm	50 – 1500 rpm
Heat output	600 W	600 W
Heating temperature	RT + device self heating – 340 °C	RT + device self heating – 310 °C
Set-up plate material	Stainless steel 1.4301	Aluminium alloy
Connection for ext. temperature sensor	PT 1000	PT 1000
Dimensions (W × H × D)	160 × 95 × 270 mm	160 × 85 × 270 mm
Protection class according to DIN EN 60529	IP 42	IP 42



- ① **RO 5**
EUR 1.337,00
Ident. No. 0003690500
- ② **RO 10**
EUR 1.543,00
Ident. No. 0003691000
- ③ **RO 15**
EUR 2.159,00
Ident. No. 0003692500



KMO 3 basic
EUR 599,00
Ident. No. 0020004631

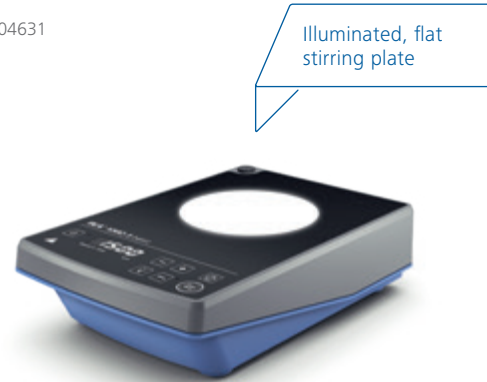

Midi MR 1 digital
EUR 3.099,00
Ident. No. 0025002968



Maxi MR 1 digital
EUR 3.399,00
Ident. No. 0025002978



TECHNICAL DATA	RO 5 RO 10 RO 15	KMO 3 BASIC	MIDI MR 1 DIGITAL	MAXI MR 1 DIGITAL
Stirring quantity max. (H ₂ O)	0,4 l per stirring position	5 l	50 l	150 l
Speed range	0 – 1200 rpm	10 – 1500 rpm	0 – 1000 rpm	0 – 600 rpm
Set-up plate material	Stainless steel 1.4301	Glass	Stainless steel 1.4301	Stainless steel 1.4301
Set-up plate dimensions	120 × 470 mm 190 × 470 mm 280 × 470 mm	140 × 120 mm	350 × 350 mm	500 × 500 mm
Dimensions (W × H × D)	120 × 60 × 570 mm 190 × 60 × 570 mm 280 × 60 × 570 mm	153 × 62,5 × 227 mm	360 × 110 × 430 mm	505 × 110 × 585 mm
Protection class according to DIN EN 60529	IP 40	IP 42	IP 21	IP 21

topolino
EUR 109,00
Ident. No. 0003368000



IKA myPlate
EUR 307,00
Ident. No. 0025005156



lab disc
EUR 289,00
Ident. No. 0003907500



Mini MR standard
EUR 219,00
Ident. No. 0025004132

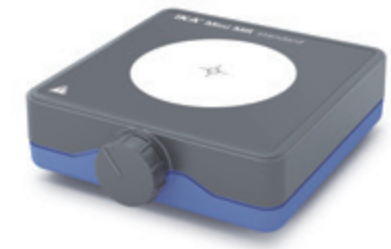

TECHNICAL DATA	TOPOLINO	IKA MYPLATE	LAB DISC	MINI MR STANDARD
Stirring quantity max. (H ₂ O)	0,25 l	1,5 l	0,8 l	1 l
Direction of rotation	–	Left	–	Right
Speed range	500 – 1800 rpm	100 – 2500 rpm	15 – 1500 rpm	0 – 2500 rpm
Set-up plate material	Synthetic (PP)	Glass	Polyester	Polyester
Set-up plate dimensions	Ø 80 mm	Ø 135 mm	Ø 100 mm	115 × 115 mm
Dimensions (W × H × D)	95 × 37 × 115 mm	152 × 30 × 164 mm	117 × 12 × 180 mm	115 × 37 × 129 mm
Protection class according to DIN EN 60529	IP 21	IP 54	IP 65	IP 42



Product	Ident. No.	Price
TEMPERATURE SENSORS		
Stainless steel		
PT 1000.60	0003516800	EUR 120,00
PT 1000.80	0004443000	EUR 127,00
PT 100.70	0020000440	EUR 115,00
Glass-coated		
PT 1000.70	0003736000	EUR 132,00
PT 100.51	0002600300	EUR 264,00
SafeCoat (PFA, PTFE)		
PT 1000.90	0004480600	EUR 169,00
PT 100.53	0004499700	EUR 270,00
Dual		
PT 1000.50	0003367600	EUR 264,00
PT 1000.51	0003377700	EUR 306,00

ELECTRONIC CONTACT THERMOMETERS

ETS-D5	0003378000	EUR 359,00
ETS-D6	0003378100	EUR 513,00

SENSORS FOR ETS-D5 / ETS-D6

H 62.51	0002735451	EUR 174,00
H 66.51, glass coated	0002735551	EUR 256,00
H 66.53, coated	0004499900	EUR 204,00
H 70, extension cable	0002735600	EUR 177,00



RET control-visc	RET basic	IKA Plate (RCT digital)	RCT basic	C-MAG HS 7 control	C-MAG HS digital 4 7 10	C-MAG HS 7 10	RH digital basic
-	•	•	•	•	•	-	-
-	+	+	+	+	+	-	-
•	-	-	-	-	-	-	-
-	+	+	+	+	+	-	-
+	-	-	-	-	-	-	-
-	+	+	+	+	+	-	-
+	-	-	-	-	-	-	-
+	-	-	-	-	-	-	-
-	+	+	+	+	-	+	+
-	+	+	+	+	-	+	+

+ Compatible | - Not compatible | • Included in delivery



Product	Hole Ø	Dimensions	Ident. No	Price
DRY HEATING BLOCK SQUARE SERIES				
H 135.10 Square carrier without handle	–	160 × 160 mm	0025000832	EUR 132,00
H 135.11 Square carrier with handle	–	160 × 160 mm	0004448200	EUR 235,00
H 135.101 Block 16 × 4 ml	15,2 mm	79 × 79 mm	0025000626	EUR 62,50
H 135.102 Block 16 × 8 ml	17,5 mm	79 × 79 mm	0025000627	EUR 62,50
H 135.103 Block 9 × 16 ml	20,5 mm	79 × 79 mm	0025000628	EUR 62,50
H 135.104 Block 4 × 20 ml	28,5 mm	79 × 79 mm	0025000629	EUR 62,50
H 135.105 Block 4 × 30 ml	28,5 mm	79 × 79 mm	0025000630	EUR 62,50
H 135.106 Block 4 × 40 ml	28,5 mm	79 × 79 mm	0025000631	EUR 62,50
H 135.107 Block 100 ml	–	79 × 79 mm	0025000632	EUR 62,50
H 135.108 Block 250 ml	–	79 × 79 mm	0025000633	EUR 62,50



H 135.11



H 135.104



H 135.21



H 135.25



H 135.301



H 135.401



H 135.501

Product	Max. outer Ø	Inner Ø	Ident. No	Price
100 ML FLASK HEATING BLOCK SERIES				
H 135.20 Flask carrier 100 ml without handle	142 mm	–	0025000634	EUR 112,00
H 135.21 Flask carrier 100 ml with handle	142 mm	–	0004448300	EUR 215,00
H 135.201 Flask inlay 10 ml	–	33,8 mm	0025000636	EUR 62,50
H 135.202 Flask inlay 25 ml	–	43,8 mm	0025000637	EUR 62,50
H 135.203 Flask inlay 50 ml	–	52,8 mm	0025000638	EUR 62,50
250 ML FLASK HEATING BLOCK SERIES				
H 135.25 Flask carrier 250 ml without handle	142 mm	–	0025003280	EUR 143,00
H 135.26 Flask carrier 250 ml with handle	142 mm	–	0020007954	EUR 246,00
500 ML FLASK HEATING BLOCK SERIES				
H 135.30 Flask carrier 500 ml without handle	142 mm	–	0025000639	EUR 153,00
H 135.31 Flask carrier 500 ml with handle	142 mm	–	0004448400	EUR 256,00
H 135.301 Flask inlay 100 ml	–	66,3 mm	0025000641	EUR 62,50
H 135.302 Flask inlay 250 ml	–	88 mm	0025000642	EUR 62,50
1000 ML FLASK HEATING BLOCK SERIES				
H 135.40 Flask carrier 1000 ml without handle	166,3 mm	–	0025000833	EUR 194,00
H 135.41 Flask carrier 1000 ml with handle	166,3 mm	–	0004448500	EUR 297,00
H 135.401 Flask inlay 500 ml	–	108 mm	0025000644	EUR 112,00
2000 ML FLASK HEATING BLOCK SERIES				
H 135.50 Flask carrier 2000 ml without handle	194,7 mm	–	0025000834	EUR 266,00
H 135.51 Flask carrier 2000 ml with handle	194,7 mm	–	0004448600	EUR 369,00
H 135.501 Flask inlay 1000 ml	–	131,8 mm	0025000645	EUR 163,00

Product	Dimensions	Ident. No	Price	Product	Dimensions	Ident. No	Price
IKAFLON® ROUND PTFE-COATED				IKAFLON® CROSS PTFE-COATED			
10 round (5 pcs.)	10 × 6 mm	0004488600	EUR 7,20	10 cross (5 pcs.)	10 × 10 mm	0004496200	EUR 13,30
15 round (5 pcs.)	15 × 6 mm	0004488700	EUR 8,20	20 cross (5 pcs.)	20 × 20 mm	0004496400	EUR 17,50
20 round (5 pcs.)	20 × 8 mm	0004488800	EUR 10,30	25 cross (5 pcs.)	25 × 25 mm	0004496600	EUR 20,50
25 round (5 pcs.)	25 × 8 mm	0004488900	EUR 12,30	30 cross (5 pcs.)	30 × 30 mm	0004496800	EUR 26,50
30 round (5 pcs.)	30 × 8 mm	0004489000	EUR 12,30	38 cross (5 pcs.)	38 × 38 mm	0004497000	EUR 32,50
40 round (5 pcs.)	40 × 8 mm	0004489100	EUR 13,30	IKAFLON® BONE PTFE-COATED			
50 round (5 pcs.)	50 × 8 mm	0004489200	EUR 14,40	37 bone (5 pcs.)	35 × 8 × 20 mm	0004497200	EUR 48,00
80 round (5 pcs.)	80 × 10 mm	0004489300	EUR 36,00	54 bone (5 pcs.)	55 × 8 × 20 mm	0004497400	EUR 58,50
110 round (1 pc.)	108 × 27 mm	0000793300	EUR 89,00	IKAFLON® BEAKER PTFE-COATED			
155 round (1 pc.)	153 × 27 mm	0001129000	EUR 99,00	74 (1 pc.)	(Ø × H): 74 × 29 mm with 60 × 9	0004497800	EUR 283,00
IKAFLON® ROUND GLASS-COATED				IKAFLON® CROWN PTFE-COATED			
25 round (5 pcs.)	25 × 6 mm	0004492200	EUR 24,00 €	9 crown (5 pcs.)	9 × 6 mm	0004498400	EUR 11,30
40 round (5 pcs.)	40 × 8 mm	0004492600	EUR 23,50 €	TRIKA® PTFE-COATED			
50 round (5 pcs.)	50 × 8 mm	0004492800	EUR 25,50 €	25 Trika (5 pcs.)	25 × 8 mm	0004499300	EUR 11,30
IKAFLON® SLIDE ROUND				35 Trika (5 pcs.)	35 × 9 mm	0004499400	EUR 17,50
25 slide (5 pcs.)	25 × 6 mm	0004493800	EUR 10,30	55 Trika (5 pcs.)	55 × 14 mm	0004499500	EUR 27,50
30 slide (5 pcs.)	30 × 6 mm	0004494000	EUR 10,30	80 Trika (5 pcs.)	80 × 17 mm	0004499600	EUR 39,00
40 slide (5 pcs.)	40 × 8 mm	0004494200	EUR 18,50	SET OF MAGNETIC STIRRING BARS			
50 slide (5 pcs.)	50 × 8 mm	0004494400	EUR 21,50	RS 1		0001358600	EUR 107,00
IKAFLON® POWER				RS 2		0004499100	EUR 122,00
20 power (5 pcs.)	20 × 6 mm	0004493000	EUR 23,50	IKAFLON® ELLIPSE PTFE-COATED			
30 power (5 pcs.)	30 × 6 mm	0004493200	EUR 36,00	20 ellipse (5 pcs.)	20 × 10 mm	0004494600	EUR 16,40
50 power (5 pcs.)	50 × 8 mm	0004493400	EUR 44,00	25 ellipse (5 pcs.)	25 × 12 mm	0004494800	EUR 17,50
IKAFLON® BEAKER PTFE-COATED				30 ellipse (5 pcs.)	32 × 16 mm	0004495000	EUR 23,50
74 (1 pc.)	(Ø × H): 74 × 29 mm with 60 × 9	0004497800	EUR 283,00	35 ellipse (5 pcs.)	35 × 15 mm	0004495200	EUR 29,50
TRIKA® PTFE-COATED				40 ellipse (5 pcs.)	40 × 20 mm	0004495400	EUR 38,00
25 Trika (5 pcs.)	25 × 8 mm	0004499300	EUR 11,30	50 ellipse (5 pcs.)	50 × 20 mm	0004495600	EUR 54,50
35 Trika (5 pcs.)	35 × 9 mm	0004499400	EUR 17,50	70 ellipse (5 pcs.)	70 × 20 mm	0004496000	EUR 95,50
55 Trika (5 pcs.)	55 × 14 mm	0004499500	EUR 27,50	IKAFLON® ROUND PTFE-coated			
80 Trika (5 pcs.)	80 × 17 mm	0004499600	EUR 39,00	IKAFLON® ellipse PTFE-coated			
SET OF MAGNETIC STIRRING BARS				IKAFLON® cross PTFE-coated			
RS 1		0001358600	EUR 107,00	IKAFLON® bone PTFE-coated			
RS 2		0004499100	EUR 122,00	IKAFLON® beaker PTFE-coated			
IKAFLON® BONE PTFE-coated				TRIKA® PTFE-coated			

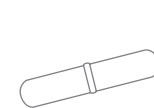
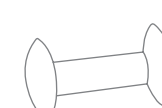
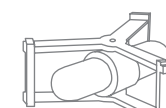
IKAFLON® round
PTFE-coatedIKAFLON® ellipse
PTFE-coatedIKAFLON® cross
PTFE-coatedIKAFLON® bone
PTFE-coatedIKAFLON® beaker
PTFE-coated

TRIKA® PTFE-coated



WiCo RET control-visc



Cover RET control-visc



IB R RO 15 eco

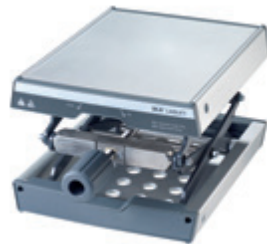

LABLIFT m



IKA Plate Adapter

Product	Description	Ident. No.	Price
WIRELESS-CONTROLLED OPERATING UNIT			
WiCo RET control-visc	Wireless remote control	0020007259	EUR 359,00
COVERS			
H 102	Cover for RH basic	0004281600	EUR 16,40
H 103	Cover for RH digital	0004299100	EUR 16,40
H 100	Cover for RCT basic and RET basic	0003661000	EUR 16,40
H 104	Cover for RET control-visc	0004209500	EUR 16,40
MAINS CABLES			
H 11	Mains cable Euro plug	0001091500	EUR 28,50
H 11	Mains cable USA plug	0003564500	EUR 28,50
H 11	Mains cable UK plug	0002410700	EUR 28,50
H 11	Mains cable CH plug	0001091600	EUR 28,50
H 11	Mains cable IN plug	0003923600	EUR 28,50
PLASTIC BATH FOR MAGNETIC STIRRER RO 15			
IB R RO 15 eco	Plastic bath, size L, 25 l volume	0020006341	EUR 790,00
LABLIFT			
LABLIFT m	Up to 25 kg (max. static load)	0004022400	EUR 269,00
IKA PLATE ADAPTER			
IKA Plate Adapter	Heating block adapter for RCT 5 digital, C-MAG 7 and 10	0025001022	EUR 159,00
STIRRING BAR REMOVER			
RSE	Stirring bar remover	0001293100	EUR 67,50
BEAKER CAP			
BC 1000	Beaker cap	0020003417	EUR 14,90

Product	Description	Ident. No.	Price
OIL BATH ATTACHMENTS			
H 29	Oil bath attachment, 1 l	0002829400	EUR 203,00
H 30	Oil bath attachment, 1,5 l	0002829500	EUR 225,00
BEAKERS, STAINLESS STEEL			
H 1000	Beaker, stainless steel, 1 l	0004444401	EUR 344,00
H 1500	Beaker, stainless steel, 1,5 l	0004444501	EUR 355,00
H 3000	Beaker, stainless steel, 3 l	0004444503	EUR 365,00
H 5000	Beaker, stainless steel, 5 l	0004444505	EUR 430,00
HEATING JACKETS			
HG 600	Heating jacket for beaker 600 ml	0020003416	EUR 99,00
HG 1000	Heating jacket for beaker 1000 ml	0020003415	EUR 119,00
HOLDERS			
H 16 V	Support rod	0001545100	EUR 61,50
H 16.3	Extension for support rod	0025000622	EUR 16,40
H 44	Boss head clamp	0002437700	EUR 29,00
H 38	Holding rod	0003547700	EUR 26,50



H 3000

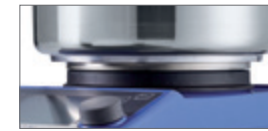

HG 600



H 16.3



H 44



LABORATORY SOFTWARE labworldsoft® 6 Starter

EUR 4.017,00

Ident. No. 0020019397

labworldsoft® 6 Pro

EUR 9.167,00

Ident. No. 0020017366

labworldsoft® is a laboratory software to control lab devices, automate processes, and to document your measurements and results. The software provides access to a huge library of different laboratory devices. labworldsoft® does not integrate only IKA laboratory devices, but supports several other devices from different manufacturers as well. You stay flexible in the choice of your lab devices you want to use and profit from the whole device range of the laboratory world.

IKA overhead stirrers are so strong, sturdy and safe because we are able to keep always an eye on the most important aspects during development. At low to high viscosities, and with up to 200 liters of stirring volume, all mixing and stirring tasks therefore constitute no challenge for our stirrers. This is a good foundation for differentiated functionalities, which include a safety circuit, a clear display, convenient control using labworldsoft® laboratory software and a wide range of stirring tools. Be it propeller stirrers, anchor stirrers or spiral stirrers - you will find the right tool for all applications in our range.

NANOSTAR 7.5 DIGITAL

/// Perfect basic functionality in the most compact of spaces



With 30% less volume and weighing just 0,8 kg, the NANOSTAR 7.5 digital overhead stirrer is even more space-saving than the MICROSTAR 7.5 digital – yet with the same performance rating.

CONSTANT TORQUE
NANOSTAR 7.5 digital guarantees an absolutely constant torque over the entire speed range of 50 – 2000 rpm.

EASE OF OPERATION
Operation takes place using a stable rotary knob. The display clearly shows the rotational speed.

RAPID UPDATES
Regular software updates can be undertaken rapidly and simply via the USB interface.

TECHNICAL DATA	NANOSTAR 7.5 DIGITAL	MICROSTAR 7.5 DIGITAL CONTROL	MICROSTAR 15 DIGITAL CONTROL	MICROSTAR 30 DIGITAL CONTROL
Stirring quantity max. (H ₂ O)	5 l	5 l	10 l	20 l
Speed range	0 50 – 2000 rpm	0 50 – 2000 rpm 0 30 – 2000 rpm	0 50 – 1000 rpm 0 30 – 1000 rpm	0 50 – 500 rpm 0 30 – 500 rpm
Viscosity max.	4000 mPas	4000 mPas	8000 mPas	20 000 mPas
Torque max. at stirring shaft	7,5 Ncm	7,5 Ncm	15 Ncm	30 Ncm
Temperature measuring range	–	– -10 – 350 °C	– -10 – 350 °C	– -10 – 350 °C
Torque measurement	–	– Trend	– Trend	– Trend
Display	LED	LED LCD	LED LCD	LED LCD
Dimensions (W x H x D)	53 x 147 x 130 mm	60 x 173 x 126 mm 60 x 173 x 136 mm	60 x 173 x 126 mm 60 x 173 x 136 mm	60 x 173 x 126 mm 60 x 173 x 136 mm
Protection class according to DIN EN 60529	IP 54	IP 54	IP 54	IP 54

MINISTAR 20 digital

EUR 859,00
Ident. No. 0025004885



MINISTAR 20 control

EUR 1.159,00
Ident. No. 0025001988

MINISTAR 40 digital

EUR 959,00
Ident. No. 0025004886



MINISTAR 40 control

EUR 1.259,00
Ident. No. 0025001989

MINISTAR 80 digital

EUR 1.059,00
Ident. No. 0025004887



MINISTAR 80 control

EUR 1.359,00
Ident. No. 0025001990



TECHNICAL DATA	MINISTAR 20 DIGITAL CONTROL	MINISTAR 40 DIGITAL CONTROL	MINISTAR 80 DIGITAL CONTROL
Stirring quantity max. (H ₂ O)	15 l	25 l	50 l
Speed range	0 50 – 2000 rpm	0 50 – 1000 rpm 0 30 – 1000 rpm	0 50 – 500 rpm 0 30 – 500 rpm
Viscosity max.	10 000 mPas	30 000 mPas	60 000 mPas
Torque max. at stirring shaft	20 Ncm	40 Ncm	80 Ncm
Temperature measuring range	- -10 – 350 °C	- -10 – 350 °C	- -10 – 350 °C
Torque measurement	- Trend	- Trend	- Trend
Display	LED LCD	LED LCD	LED LCD
Dimensions (W x H x D)	70 x 193 x 147 mm 70 x 193 x 154 mm	70 x 193 x 147 mm 70 x 193 x 154 mm	70 x 193 x 147 mm 70 x 193 x 154 mm
Protection class according to DIN EN 60529	IP 54	IP 54	IP 54

EUROSTAR 20 digital

EUR 959,00
Ident. No. 0004442000



EUROSTAR 40 digital

EUR 1.249,00
Ident. No. 0004444000

Quiet operation with brushless DC motor

EUROSTAR 60 digital

EUR 1.399,00
Ident. No. 0004446000



EUROSTAR 100 digital

EUR 1.998,00
Ident. No. 0004238100



EUROSTAR 100 control

EUR 2.449,00
Ident. No. 0004028500

EUROSTAR 200 digital

EUR 2.568,00
Ident. No. 0003990000



EUROSTAR 200 control

EUR 2.949,00
Ident. No. 0003992000

TECHNICAL DATA	EUROSTAR 20 DIGITAL 40 DIGITAL	EUROSTAR 60 DIGITAL CONTROL	EUROSTAR 100 DIGITAL CONTROL	EUROSTAR 200 DIGITAL CONTROL
Stirring quantity max. (H ₂ O)	15 l 25 l	40 l	100 l	100 l
Speed range	0 30 – 2000 rpm	0 30 – 2000 rpm	0 30 – 1300 rpm	I: 0 6 – 400 rpm II: 30 – 2000 rpm
Viscosity max.	10 000 mPas	50 000 mPas	70 000 mPas	100 000 mPas
Torque max. at stirring shaft	20 Ncm 40 Ncm	60 Ncm	100 Ncm	I: 200 Ncm II: 40 Ncm
Display	LED	LED TFT	LED TFT	LED TFT
Temperature measuring range	- -	- -10 – 350 °C	- -10 – 350 °C	- -10 – 350 °C
Dimensions (W x H x D)	86 x 248 x 208 mm	86 x 248 x 208 mm 86 x 267 x 230 mm	86 x 248 x 208 mm 86 x 267 x 230 mm	91 x 274 x 209 mm 91 x 297 x 231 mm
Protection class according to DIN EN 60529	IP 42	IP 42 IP 40	IP 42 IP 40	IP 42 IP 40

EUROSTAR 400 digital

EUR 3.223,00
Ident. No. 0004214000



EUROSTAR 400 control

EUR 3.599,00
Ident. No. 0004214100



EUROSTAR 20 high speed digital

EUR 1.899,00
Ident. No. 0004028600

EUROSTAR 20 high speed control

EUR 2.499,00
Ident. No. 0025001314

EUROSTAR 100 control P4

EUR 3.499,00
Ident. No. 0025004384



EUROSTAR 200 control P4

EUR 3.999,00
Ident. No. 0004090000

Extremely powerful stirrer for highly viscous applications



TECHNICAL DATA	EUROSTAR 400 DIGITAL CONTROL	EUROSTAR 20 HIGH SPEED DIGITAL CONTROL	EUROSTAR 100 CONTROL P4	EUROSTAR 200 CONTROL P4
Stirring quantity max. (H ₂ O)	150 l	20 l	100 l	100 l
Speed range	I: 6 – 400 rpm II: 30 – 2000 rpm	0 150 – 6000 rpm	10 – 300 rpm	I: 0 4 – 108 rpm II: 16 – 530 rpm
Viscosity max.	100 000 mPas	10 000 mPas	100 000 mPas	150 000 mPas
Torque max. at stirring shaft	I: 400 Ncm II: 80 Ncm	20 Ncm	320 Ncm	I: 660 Ncm II: 130 Ncm
Display	LED TFT	LED TFT	TFT	TFT
Temperature measuring range	- -10 – 350 °C	- -10 – 350 °C	-10 – 350 °C	-10 – 350 °C
Dimensions (W x H x D)	114 x 325 x 245 mm 114 x 345 x 268 mm	86 x 325 x 208 mm 86 x 325 x 230 mm	86 x 352 x 230 mm	91 x 379 x 231 mm
Protection class according to DIN EN 60529	IP 42 IP 40	IP 42 IP 40	IP 40	IP 40

RW 20 digital

EUR 1.199,00
Ident. No. 0003593000



RW 28 digital

EUR 2.999,00
Ident. No. 0005040000



RW 47 digital

EUR 5.405,00
Ident. No. 0004050000



TECHNICAL DATA	RW 20 DIGITAL	RW 28 DIGITAL	RW 47 DIGITAL
Stirring quantity max. (H ₂ O)	20 l	80 l	200 l
Speed range	I: 60 – 500 rpm II: 240 – 2000 rpm	I: 60 – 400 rpm II: 240 – 1400 rpm	I: 57 – 275 rpm II: 275 – 1300 rpm
Viscosity max.	10 000 mPas	50 000 mPas	100 000 mPas
Torque max. at stirring shaft	I: 150 Ncm II: 24 Ncm	I: 900 Ncm II: 300 Ncm	I: 3000 Ncm II: 620 Ncm
Display	LED	LED	LED
Dimensions (W x H x D)	88 x 294 x 212 mm	123 x 364 x 252 mm	145 x 465 x 358 mm
Protection class according to DIN EN 60529	IP 20	IP 40	IP 54

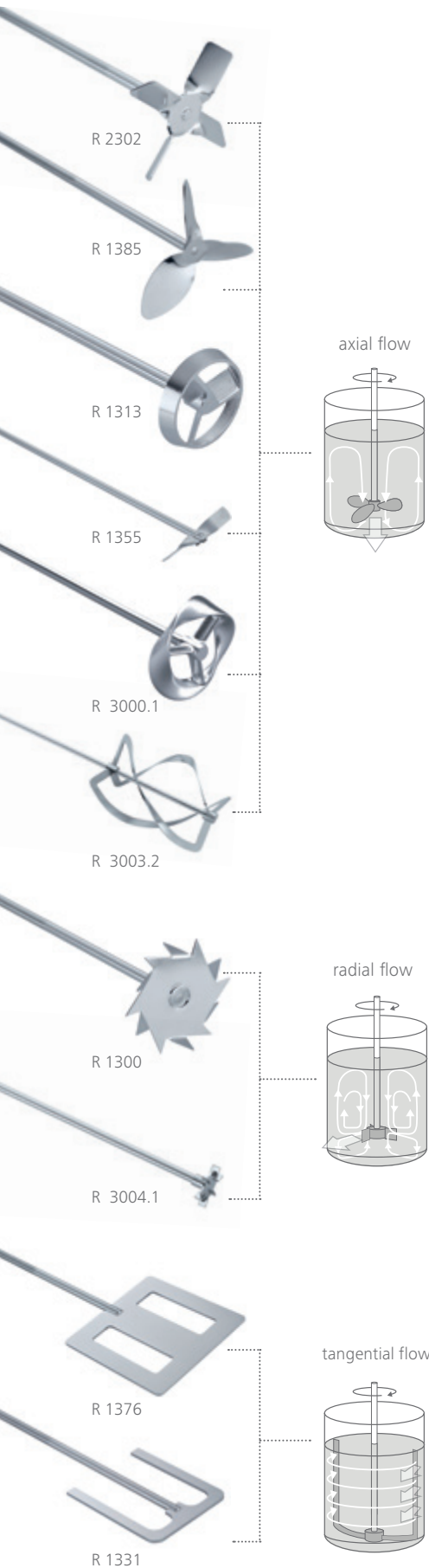

Product	Shaft length Shaft diameter Stirrer diameter	Ident. No.	Price
PROPELLER STIRRERS, 4-BLADED			
R 1342	350 8 50 mm	0000741000	EUR 132,00
R 1345	550 8 100 mm	0000741300	EUR 163,00
R 2302	800 13 150 mm	0000739000	EUR 575,00
PROPELLER STIRRERS, 3-BLADED			
R 1381	350 8 45 mm	0001296000	EUR 266,00
R 1382	350 8 55 mm	0001295900	EUR 277,00
R 1385	550 10 140 mm	0000477700	EUR 266,00
R 1388	800 10 140 mm	0000477800	EUR 318,00
R 1389*	350 8 75 mm	0002343600	EUR 483,00
TURBINE STIRRERS			
R 1311	350 8 30 mm	0002332900	EUR 179,00
R 1312	350 8 50 mm	0002333000	EUR 229,00
R 1313	400 10 70 mm	0002333100	EUR 279,00
CENTRIFUGAL STIRRERS			
R 1352	350 8 60/15 mm	0000756900	EUR 149,00
R 1355	550 8 100/24 mm	0001132700	EUR 199,00
DISSOLVER STIRRERS			
R 1300	350 8 80 mm	0000513500	EUR 235,00
R 1302	350 10 100 mm	0002387900	EUR 499,00
R 1303	350 8 40 mm	0002746700	EUR 369,00
PADDLE STIRRERS			
R 1375	550 8 70 mm	0000757700	EUR 159,00
R 1376	550 10 150 mm	0000757800	EUR 318,00
R 2311	800 13 150 mm	0000739500	EUR 529,00
ANCHOR STIRRERS			
R 1330	350 8 45 mm	0002022300	EUR 339,00
R 1331	350 8 90 mm	0002022400	EUR 410,00
R 1333	550 10 150 mm	0002747400	EUR 668,00
MOEBIUS STIRRERS			
R 3000.1	565 10 100 mm	0020001192	EUR 369,00
R 3001.1	575 10 100 mm	0020001195	EUR 389,00
SPIRAL STIRRERS			
R 3003	350 8 50 mm	0020001203	EUR 299,00
R 3003.1	550 10 100 mm	0020001204	EUR 429,00
R 3003.2	800 10 150 mm	0020001205	EUR 549,00
BLADE STIRRERS			
R 3004	359 8 30 mm	0020001206	EUR 259,00
R 3004.1	565 10 50 mm	0020001207	EUR 359,00
R 3004.2	819 10 70 mm	0020001208	EUR 459,00
PADDLE STIRRERS SCREW-TYPE STIRRERS			
R 1001	160 4 34 mm	0000527400	EUR 139,00
R 1002	140 4 12 mm	0000527500	EUR 119,00

* (PTFE-coated)

NANO-STAR digital	MICRO-STARS digital control	MINI-STARS digital control	EUROSTAR 20 40 digital	EUROSTAR 60 digital control	EUROSTAR 100 digital control	EUROSTAR 200 digital control	EUROSTAR 400 digital control	EUROSTAR 100 & 200 control P4	RW 20 digital	RW 28 digital	RW 47 digital
++	++	++	++	+	+	+	+	+	+	+	+
+	+	++	++	++	+	+	+	+	+	+	+
-	-	-	-	-	-	-	++	-	-	-	++
++	++	++	++	++	+	+	+	+	+	+	+
++	++	++	++	++	+	+	+	+	+	+	+
-	-	-	++	++	++	+	+	+	+	+	+
-	-	-	+	+	+	+	+	+	+	+	+
++	++	++	++	++	+	+	+	+	+	+	+
++	++	++	++	++	+	+	+	+	+	+	+
-	-	-	++	++	++	+	+	+	+	+	+
++	++	++	++	++	+	+	+	+	+	+	+
++	++	++	++	++	+	+	+	+	+	+	+
-	-	-	++	++	++	+	+	+	+	+	+
++	++	++	++	++	+	+	+	+	+	+	+
+	+	++	++	++	+	+	+	+	+	+	+
-	-	-	++	++	++	+	+	+	+	+	+
-	-	-	-	-	-	-	++	-	-	-	++
++	++	++	++	++	+	+	+	+	+	+	+
++	++	++	++	++	+	+	+	+	+	+	+
-	-	-	++	++	++	+	+	+	+	+	+
-	-	-	+	++	++	+	+	+	+	+	+
-	-	-	+	++	++	+	+	+	+	+	+
++	++	++	++	++	+	+	+	+	+	+	+
+	+	+	++	++	+	+	+	+	+	+	+
-	-	-	+	+	+	+	++	++	+	+	+
++	++	++	++	++	+	+	+	+	+	+	+
++	++	++	++	++	+	+	+	+	+	+	+

++ IKA recommended | + Installable | - Not compatible

Product	Ident. No.	Price	NANOSTAR digital	MICRO-STARS digital control	MINISTARS digital control
TEMPERATURE SENSORS					
H 67.60 stainless steel	0025006664	EUR 129,00	control	control	control
H 67.61 stainless steel	0020003865	EUR 189,00	control	control	control
H 68.55 stainless steel	0025001479	EUR 245,00	control	control	control
H 70 extension cable	0002735600	EUR 177,00	control	control	control



SENSORS IN COMBINATION WITH H 70

H 62.51 stainless steel	0002735451	EUR 174,00	-	-	-
H 66.51 glass-coated	0002735551	EUR 256,00	-	-	-
H 66.53 coated	0004499900	EUR 204,00	-	-	-

STANDS

Plate stands

IKA [scale]	0025004318	EUR 719,00	++	++	++
R 1825	0003160000	EUR 254,00	++	++	++
R 1826	0003160100	EUR 279,00	++	++	++
R 1827	0003160200	EUR 299,00	++	++	++

H-stand

R 2722	0001412000	EUR 655,00	++	++	++
--------	------------	------------	----	----	----

Telescopic stands

R 2723	0001412100	EUR 1.214,00	++	++	++
R 474	0001643000	EUR 1.599,00	-	-	-

Floor stands

R 472	0000738700	EUR 3.399,00	-	-	-
R 2850	0020002900	EUR 2.499,00	-	-	-
R 6547 H	0020018378	EUR 7.099,00	-	-	-
R 6547 E 400V	0020018384	EUR 12.099,00	-	-	-

IKA [scale]



EUROSTAR 20 40 digital	EUROSTAR 60 digital control	EUROSTAR 100 digital control	EUROSTAR 200 digital control	EUROSTAR 400 digital control	EUROSTAR 100 & 200 control P4	EUROSTAR 20 high speed digital control	RW 20 digital	RW 28 digital	RW 47 digital
-	control	control	control	control	++	control	-	-	-
-	control	control	control	control	++	control	-	-	-
-	control	control	control	control	++	control	-	-	-
-	control	control	control	control	++	control	-	-	-
-	control	control	control	control	control P4	20 hs control	-	-	-
-	control	control	control	control	control P4	20 hs control	-	-	-
-	control	control	control	control	control P4	20 hs control	-	-	-
++	++	++	++	-	++	++	++	-	-
++	++	++	++	-	++	++	++	-	-
++	++	++	++	-	++	++	++	-	-
++	++	++	-	-	-	++	++	-	-
++	++	++	++	++	++	++	++	++	-
++	++	++	++	++	++	++	++	++	-
-	-	-	-	-	-	-	-	-	++
-	-	++	++	++	++	-	-	++	-
-	-	-	-	-	-	-	-	-	++
-	-	-	-	-	-	-	-	-	++

++ IKA recommended | + Installable | - Not compatible

CLAMPS // Compatibility with stands (++ / -)

Product	R 182	R 270	R 271	RH 3	RH 5
IKA [scale]	++	-	-	++	-
R 1825	++	-	-	++	-
R 1826	++	-	-	++	-
R 1827	++	-	-	++	-
R 2722	-	++	++	-	++
R 2723	-	++	++	-	++



R 270



R 271



RH 3



R 1401



R 1402



R 301



WH 11



Product	Description	Ident. No.	Price
ACCESSORIES EUROSTAR 20 HIGH SPEED DIGITAL AND CONTROL			
R 1401	Propeller, Ø 55 mm	0001242900	EUR 229,00
R 1405	Propeller, Ø 45 mm	0001289800	EUR 184,00
R 1402	Dissolver, Ø 42 mm	0001243300	EUR 256,00
ACCESSORIES FOR PROTECTION AND SAFETY			
R 301	Stirring shaft protection	0002603000	EUR 159,00
R 301.1	Support holder for R 301	0002604000	EUR 189,00
R 303	Stirring shaft protection	0030000257	EUR 379,00
SI 400	Safety switch	0003294800	EUR 839,00
SI 472	Fixing device for SI 400 to R 472 stand	0003264000	EUR 789,00
SI 474	Fixing device for SI 400 to R 474 or T 653 stand	0003264400	EUR 359,00
FURTHER ACCESSORIES			
WH 11	Wall mount for WiCo	0025001500	EUR 25,00
FK 1	Flexible coupling	0002336000	EUR 269,00
R 60	Keyless chuck	0003889500	EUR 69,00
R 60.1	Keyless chuck	0025007821	EUR 69,00

LABORATORY SOFTWARE

labworldsoft® 6 Starter

EUR 4.017,00

Ident. No. 0020019397

labworldsoft® 6 Pro

EUR 9.167,00

Ident. No. 0020017366

labworldsoft® is a laboratory software to control lab devices, automate processes, and to document your measurements and results. The software provides access to a huge library of different laboratory devices. labworldsoft® does not integrate only IKA laboratory devices, but supports several other devices from different manufacturers as well. You stay flexible in the choice of your lab devices you want to use and profit from the whole device range of the laboratory world.



SAFETY FIRST

Stress-free mixing at your convenience with increased productivity, flexibility and enhanced safety features. A safety stop function allows for example the quick stop of the overhead stirrer. Stirring shaft protection, which is available as an accessory prevents potential injuries due to the rotating shafts and stirring elements. The clear display of the control versions shows all relevant values such as torque and speed as well as PC connectivity if the device is controlled with labworldsoft®. This ensures a constant overview of the stirring process.

Since 1925 IKA has a line of well known and proven orbital and horizontal shakers. The wide range of Rocking, Rolling, Rotating and Shaking covers the entire spectrum of motions in mixing technology. To give our customers a leading edge IKA ensures that innovative products are introduced time and time again. Most recently, the shaker line has been completely revamped by incorporating advanced technology with unique designs. In 2019 an all new product family extended the existing portfolio: IKA Matrix thermoshakers.

IKA MATRIX

/// The new IKA thermoshakers

Mixing, heating, cooling, or all at once? With the IKA Matrix, there is a new powerful product family of thermoshakers available. Regardless whether blood samples, pharmaceutical agents, DNA / RNA samples or ELISA assays – samples with even the smallest volumes are mixed reliably and completely in all laboratory applications. No cross-contamination and an optimal mixing result.



INTUITIVE USE

The large clear display allows an absolutely intuitive navigation. An user-friendly, self-explanatory menu structure awaits you.

HIGH SPEED

Speeds of up to 3000 rpm ensure that the liquid is mixed particularly quick and effective thanks to its orbital movement.

EXTRA STABLE HOUSING

Excellent stability and everyday robustness is achieved by the aluminium die cast housing. This ensures a secure positioning and strengthens the whole device.

VARIABLE INSERTS

There is an extensive range of accessories available for the IKA Matrix series that allows the optimal operation of your specific application.

Matrix Δ+ / Matrix Orbital Δ+ available from Q3 / 2020

Matrix Orbital

EUR 1.699,00

Ident. No. 0030000627



① Matrix Orbital Δ F0.5

EUR 2.299,00

Ident. No. 0030000747

③ Matrix Orbital Δ F1.5

EUR 2.299,00

Ident. No. 0030000750

② Matrix Orbital Δ FP

EUR 2.299,00

Ident. No. 0030000751

④ Matrix Orbital Δ F2.0

EUR 2.299,00

Ident. No. 0030000753



Matrix Δ+

EUR 1.699,00

Ident. No. 0030000717



Matrix Orbital Δ+

EUR 2.399,00

Ident. No. 0030000731



TECHNICAL DATA	MATRIX ORBITAL	MATRIX ORBITAL Δ F0.5 FP F1.5 F2.0	MATRIX Δ+	MATRIX ORBITAL Δ+
Type of movement	Orbital	Orbital	–	Orbital
Speed range	300 – 3000 rpm	F1.5 F2.0: 300 – 1500 rpm FP F0.5: 300 – 2000 rpm	–	300 – 3000 rpm
Heating range	–	RT +5 °C – 100 °C	RT -30 °C – 110 °C	RT -15 °C – 100 °C
Permissible shaking weight (incl. attachment)	0,3 kg	0,3 kg	0,3 kg	0,3 kg
Operating mode	Timer and continuous operation	Timer and continuous operation	Timer and continuous operation	Timer and continuous operation
Dimensions (W x H x D)	198 x 124 x 318 mm	220 x 150 x 350 mm	200 x 125 x 350 mm	200 x 125 x 350 mm
Protection class according to DIN EN 60529	IP 21	IP 21	IP 21	IP 21

① **ROCKER 2D basic**

EUR 799,00
Ident. No. 0004002000

② **ROCKER 2D digital**

EUR 849,00
Ident. No. 0004003000



① **ROCKER 3D basic**

EUR 849,00
Ident. No. 0004000000

② **ROCKER 3D digital**

EUR 899,00
Ident. No. 0004001000



① **ROLLER 6 basic**

EUR 1.349,00
Ident. No. 0004010000

② **ROLLER 6 digital**

EUR 1.399,00
Ident. No. 0004011000



ROLLER 10 basic

EUR 1.649,00
Ident. No. 0004012000

② **ROLLER 10 digital**

EUR 1.699,00
Ident. No. 0004013000



TECHNICAL DATA	ROCKER 2D BASIC DIGITAL	ROCKER 3D BASIC DIGITAL	ROLLER 6 BASIC DIGITAL	ROLLER 10 BASIC DIGITAL
Type of movement	Rocking	Tumbling	Rolling	Rolling
Speed range	0 – 80 rpm	30 rpm 0 – 80 rpm	30 rpm 0 – 80 rpm	30 rpm 0 – 80 rpm
Timer display	– 7 segment LED	– 7 segment LED	– 7 segment LED	– 7 segment LED
Speed display	– 7 segment LED	– 7 segment LED	– 7 segment LED	– 7 segment LED
Operating mode	Continuous operation Timer and continuous operation	Continuous operation Timer and continuous operation	Continuous operation Timer and continuous operation	Continuous operation Timer and continuous operation
Dimensions (W x H x D)	280 x 150 x 330 mm	280 x 165 x 330 mm 280 x 185 x 330 mm	240 x 115 x 545 mm	380 x 115 x 545 mm
Protection class according to DIN EN 60529	IP 21	IP 21	IP 21	IP 21

① **Loopster basic**

EUR 719,00
Ident. No. 0004015000

② **Loopster digital**

EUR 771,00
Ident. No. 0004016000



① **Trayster basic**

EUR 799,00
Ident. No. 0004005000

② **Trayster digital**

EUR 849,00
Ident. No. 0004006000

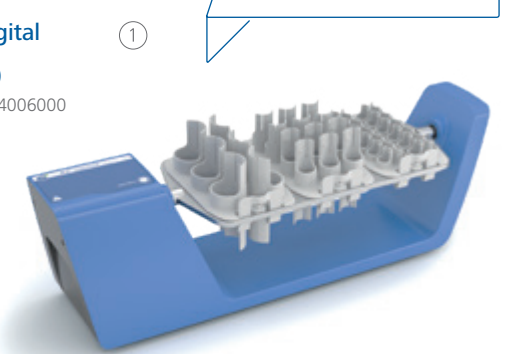

① **Hula Dancer basic**

EUR 299,00
Ident. No. 0025004320

② **Hula Dancer digital**

EUR 349,00
Ident. No. 0025003634



① **MS 3 basic**

EUR 549,00
Ident. No. 0003617000

② **MS 3 digital**

EUR 749,00
Ident. No. 0003319000

③ **MS 3 control**

EUR 799,00
Ident. No. 0020016017



TECHNICAL DATA	LOOPSTER BASIC DIGITAL	TRAYSTER BASIC DIGITAL	HULA DANCER BASIC DIGITAL	MS 3 BASIC DIGITAL CONTROL
Type of movement	Rotating	Overhead	Orbital	Orbital
Permissible shaking weight (incl. attachment)	2 kg	2 kg	0,1 kg	0,5 kg
Speed range	20 rpm 0 – 80 rpm	20 rpm 0 – 80 rpm	2800 rpm 1200 – 2800 rpm	0 – 3000 rpm 0 – 3000 rpm 100 – 3000 rpm
Timer display	– 7 segment LED	– 7 segment LED	– –	– 7 segment LED LCD
Operating mode	Continuous operation Timer and continuous operation	Continuous operation Timer and continuous operation	–	Continuous operation Timer and continuous operation Timer and continuous operation
Dimensions (W x H x D)	300 x 360 x 300 mm	460 x 180 x 140 mm	123 x 42 x 123 mm	148 x 63 x 205 mm
Protection class according to DIN EN 60529	IP 21	IP 21	IP 42	IP 21

① **KS 3000 i control**

EUR 5.148,00
Ident. No. 0003940000

② **KS 3000 ic control**

EUR 6.178,00
Ident. No. 0003940100

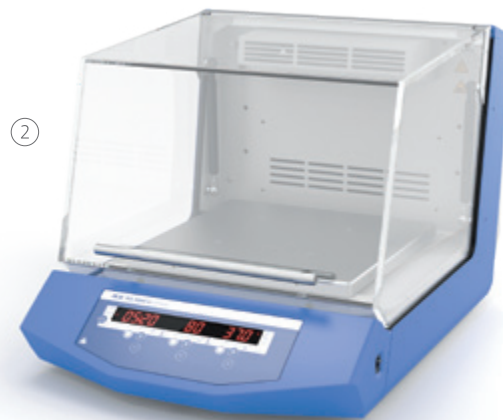

KS 3000 ic with built-in cooler

Allows unattended operation

① **KS 4000 i control**

EUR 6.230,00
Ident. No. 0003510000

② **KS 4000 ic control**

EUR 7.260,00
Ident. No. 0003510100



TECHNICAL DATA	KS 3000 I IC	KS 4000 I IC
Type of movement	Orbital	Orbital
Permissible shaking weight (incl. attachment)	7,5 kg	20 kg
Speed range	10 – 500 rpm	10 – 500 rpm
Timer display	7 segment LED	7 segment LED
Speed display	LED	LED
Operating mode	Timer and continuous operation	Timer and continuous operation
Temperature range (inlet T>3°C)	RT +5 °C – 80 °C RT -10 °C – 80 °C	RT +5 °C – 80 °C RT -10 °C – 80 °C
Total volume inner chamber	50 l	90 l
Dimensions (W x H x D)	465 x 430 x 695 mm	580 x 525 x 750 mm
Protection class according to DIN EN 60529	IP 30	IP 30

VORTEX 2

EUR 235,00
Ident. No. 0025000258

VORTEX 3

EUR 369,00
Ident. No. 0003340000



HANDS FOR CHILDREN

The aid project HANDS FOR CHILDREN was created in 2000 by IKA owner and Managing Director René Stiegelmann. In the context of this voluntary initiative, retired IKA employees assemble laboratory equipment free-of-charge, so that the proceeds can be used for children's charity programs. More than 2000 voluntary hours per year are used for the benefit of medical care for disabled children in Uganda and for schooling programs in Tanzania, for example.



VXR basic Vibrax®

EUR 1.449,00
Ident. No. 0002819000

MTS 2/4 digital

EUR 1.543,00
Ident. No. 0003208000

For shaking two or four microtiter plates



TECHNICAL DATA	VORTEX 2	VORTEX 3	VXR BASIC VIBRAX®	MTS 2/4 DIGITAL
Type of movement	Orbital	Orbital	Orbital	Orbital
Speed range	500 – 2500 rpm	0 – 2500 rpm	0 – 2200 rpm	0 – 1100 rpm
Timer	No	No	No	Yes
Speed display	Scale	–	Scale	Scale
Operating mode	Continuous operation	Continuous operation	Continuous operation	Timer and continuous operation
Permissible shaking weight (incl. attachment)	0,4 kg	0,5 kg	2 kg	1 kg; 2/4 MT-plates
Dimensions (W x H x D)	120 x 140 x 138 mm	127 x 136 x 149 mm	157 x 130 x 247 mm	185 x 105 x 320 mm
Protection class according to DIN EN 60529	IP 21	IP 21	IP 21	IP 21

① **KS 130 basic**

EUR 1.499,00
Ident. No. 0002980000

② **KS 130 control**

EUR 2.199,00
Ident. No. 0002980100

③ **KS 130 control NOL**

EUR EUR 2.199,00
Ident. No. 0004278200

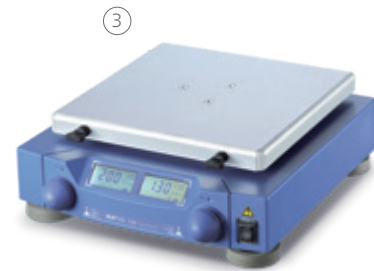

① **KS 260 basic**

EUR 2.399,00
Ident. No. 0002980200

② **KS 260 control**

EUR 2.999,00
Ident. No. 0002980300

③ **KS 260 control NOL**

EUR 2.999,00
Ident. No. 0004278400



① **HS 260 basic**

EUR 2.399,00
Ident. No. 0003066600

② **HS 260 control**

EUR 2.999,00
Ident. No. 0003066700

HS 260 control NOL

EUR 2.999,00
Ident. No. 0004278600



① **HS 501 digital**

EUR 4.449,00
Ident. No. 0025002982

② **KS 501 digital**

EUR 4.449,00
Ident. No. 0025002985

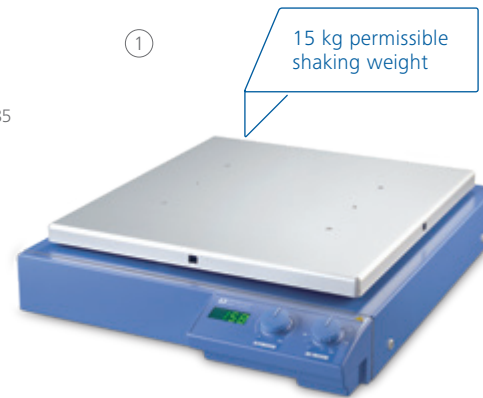

TECHNICAL DATA	KS 130 BASIC CONTROL	KS 260 BASIC CONTROL	HS 260 BASIC CONTROL	HS 501 DIGITAL KS 501 DIGITAL
Type of movement	Orbital	Orbital	Reciprocating	Reciprocating Orbital
Shaker diameter	4 mm	10 mm	20 mm	30 mm
Permissible shaking weight (incl. attachment)	2,0 kg	7,5 kg	7,5 kg	15 kg
Speed range	0 – 800 rpm	0 – 500 rpm	0 – 300 rpm 10 – 300 rpm	0 – 300 rpm
Timer display	LED line LCD	LED line LCD	LED line LCD	Scale
Speed display	LED line LCD	LED line LCD	LED line LCD	7 segment LED
Operating mode	Timer and continuous operation	Timer and continuous operation	Timer and continuous operation	Timer and continuous operation
Dimensions (W x H x D)	270 x 98 x 316 mm	360 x 98 x 420 mm	360 x 100 x 420 mm	505 x 120 x 585 mm
Protection class according to DIN EN 60529	IP 21	IP 21	IP 21	IP 21

Product	Description	Ident. No.	Price
ACCESSORIES TEMPERATURE CONTROL AND MIXING			
Matrix Cover	Cover	0030001253	EUR 99,00
Matrix Thermo Cover	Cover, heatable	0030001244	EUR 499,00
① Matrix PCR 96 attachment	Attachment for 96 PCR plates	0030000853	EUR 599,00
Matrix PCR 384 attachment	Attachment for 384 PCR plates	0030000857	EUR 599,00
② Matrix 0,5 ml attachment	Attachment for vials, 24 x 0,5 ml vials	0030000840	EUR 499,00
③ Matrix 1,5 ml attachment	Attachment for vials, 24 x 1,5 ml vials	0030000829	EUR 499,00
Matrix 2,0 ml attachment	Attachment for vials, 24 x 2,0 ml vials	0030000834	EUR 499,00
Matrix 5 ml attachment	Attachment for vials, 8 x 5 ml vials	0030000859	EUR 499,00
Matrix 12 ml attachment	Attachment for vials, 24 x 12 ml vials	0030000844	EUR 499,00
Matrix 15 ml attachment	Attachment for vials, 8 x 15 ml vials	0030000821	EUR 499,00
Matrix 50 ml attachment	Attachment for vials, 4 x 50 ml vials	0030000863	EUR 499,00
Matrix Cryo attachment	Attachment for vials, 24 x cryo vials	0030000848	EUR 499,00
Matrix 0,5 ml insert	Insert for 0,5 ml vials	0030001157	EUR 39,00
Matrix 1,5 / 2,0 ml insert	Insert for 1,5 / 2,0 ml vials	0030001158	EUR 39,00
Matrix PCR insert	Insert for 0,2 ml PCR vials	0030001159	EUR 39,00
Matrix plate attachment	Attachment for microplates	0030000849	EUR 599,00



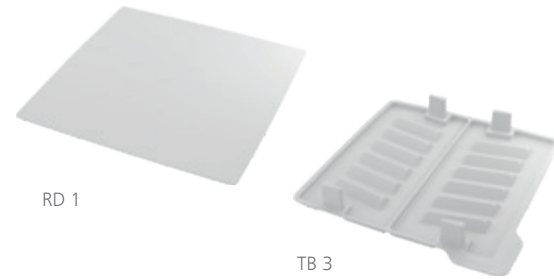

RD 1

TB 3

Product	Description	Ident. No.	Price
ACCESSORIES ROCKER			
A 2	Second level attachment	0004581700	EUR 61,50
RD 1	Universal mat	0004532000	EUR 18,50
RD 2	Burled mat	0004532100	EUR 20,50
TB 1	Tray, 28 x 5 ml, Ø 12 mm	0004532200	EUR 33,50
TB 2	Tray, 16 x 15 ml, Ø 16 mm	0004532300	EUR 33,50
TB 3	Tray, 14 x 30 ml, Ø 25 mm	0004532400	EUR 33,50
TB 4	Tray, 10 x 30 ml, Ø 28 mm	0004532500	EUR 33,50

ACCESSORIES LOOPSTERDS 2
Tube attachmentDS 4
Tube attachment

DS 6.1

DS 6.2



DS 6.3

DS 6.4

DS 1	Tube attachment, 48 x 1,5 ml, Ø 10 mm	0004524000	EUR 186,00
DS 2	Tube attachment, 24 x 5 ml, Ø 12 mm	0004524100	EUR 133,00
DS 3	Tube attachment, 20 x 15 ml, Ø 16 mm	0004524200	EUR 133,00
DS 4	Tube attachment, 2 x 30 ml, Ø 25 mm	0004524300	EUR 133,00
DS 5	Tube attachment, 12 x 50 ml, Ø 28 mm	0004524400	EUR 133,00
DS 6	Universal disc	0004524500	EUR 113,00
DS 6.1	Spare clips, Ø 10 mm, 12 pcs.	0004524600	EUR 33,50
DS 6.2	Spare clips, Ø 12 mm, 12 pcs.	0004524700	EUR 33,50
DS 6.3	Spare clips, Ø 16 mm, 12 pcs.	0004524800	EUR 33,50
DS 6.4	Spare clips, Ø 25 mm, 12 pcs.	0004524900	EUR 33,50
DS 6.5	Spare clips, Ø 28 mm, 12 pcs.	0004525000	EUR 33,50

ACCESSORIES TRAYSTER

TR 1

TR 2

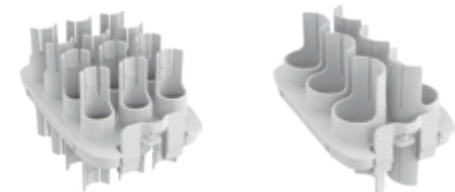

TR 3

TR 4

TR 1	Tube insert, 24 x 1,5 ml, Ø 10 mm	0004525100	EUR 40,00
TR 2	Tube insert, 24 x 5 ml, Ø 12 mm	0004525200	EUR 40,00
TR 3	Tube insert, 12 x 15 ml, Ø 16 mm	0004525300	EUR 40,00
TR 4	Tube insert, 6 x 50 ml, Ø 28 mm	0004525400	EUR 40,00



MS 3.1

MS 1.33

MS 1.32

MS 1.31

MS 3.3

VG 3.1

VG 3.35

VG 3.34

VG 3.31

VG 3.3

Product	Description	Ident. No.	Price
ACCESSORIES MS 3 BASIC DIGITAL CONTROL			
MS 3.1	Standard attachment	0003426300	EUR 15,40
MS 3.3	Universal attachment	0003426600	EUR 15,40
MS 1.21	One-hand insert	L001540	EUR 21,50
MS 1.30	Attachment for 0,5 ml tubes	0025005776	EUR 46,00
MS 1.31	Test tube insert, 14 x Ø 10 mm	L001840	EUR 48,00
MS 1.32	Test tube insert, 6 x Ø 12 mm	L001850	EUR 48,00
MS 1.33	Test tube insert, 4 x Ø 16 mm	L001860	EUR 48,00
MS 1.34	Test tube insert	L001830	EUR 22,50
MS 3.4	Microtiter plate attachment	0003426400	EUR 48,00
MS 3.5	PCR plate attachment, 96-well	0003428000	EUR 48,00

ACCESSORIES VORTEX 2 | VORTEX 3

VG 3.1	Standard attachment	0003341200	EUR 10,30
VG 3.2	One-hand attachment	0003342300	EUR 21,50
VG 3.21	Rubber mat	0020008398	EUR 19,00
VG 3.3	Universal attachment, 150 mm	0003342400	EUR 23,50
VG 3.30	Attachment for PCR-tubes, 0,2 ml	0025005779	EUR 29,50
VG 3.31	Test tube attachment for 54 Eppendorf tubes	0003344300	EUR 57,50
VG 3.32	Test tube attachment, 18 x Ø 10 mm	0003343900	EUR 29,50
VG 3.33	Test tube attachment, 12 x Ø 12 mm	0003344000	EUR 29,50
VG 3.34	Test tube attachment, 8 x Ø 16 mm	0003344100	EUR 29,50
VG 3.35	Test tube attachment, 8 x Ø 20 mm	0003344200	EUR 29,50
VG 3.36	Erlenmeyer flask attachment, 100 – 250 ml	0003342100	EUR 29,50
VG 3.37	Microtiter plate attachment	0003344400	EUR 29,50

New accessory



VX 2E.n



VX 2



VX 11.1



AS 130.1



AS 260.3



AS 1.10



AS 501.2



AS 501.3



AS 501.6

Product	Description	Ident. No.	Price
ACCESSORIES VXR			
VX 1	One-hand attachment, 1 – 250 ml	0000607200	EUR 91,50
VX 2	Test tube attachment, 36 x Ø 16 mm	0000568900	EUR 380,00
VX 2E.n	Eppendorf attachment, 64 x 1,5 ml	0020018016	EUR 369,00
VX 7	Dish attachment	0000953300	EUR 268,00
VX 8	Universal attachment	0000910400	EUR 646,00
VX 11	Basic holder	0003627700	EUR 139,00
VX 11.1	Test tube insert, 70 x Ø 10 mm	0003659000	EUR 139,00
VX 11.2	Test tube insert, 41 x Ø 12 mm	0003659100	EUR 139,00
VX 11.3	Test tube insert, 32 x Ø 16 mm	0003659200	EUR 106,00
VX 11.4	Test tube insert, 18 x Ø 20 mm	0003659300	EUR 106,00
VX 11.5	Attachment for 30 ml tubes, 12 x Ø 23 mm	0025005778	EUR 95,50
VX 11.6	Attachment for 50 ml tubes, 8 x Ø 27 mm	0025005777	EUR 95,50
VX 8.1	Clamping roll	0003375400	EUR 35,00

Product	Description	Ident. No.	Price
ACCESSORIES KS 130 BASIC CONTROL			
AS 130.1	Universal attachment	0008017300	EUR 322,00
AS 130.2	Fixing clip attachment	0003115000	EUR 96,50
AS 130.3	Dish attachment	0003120000	EUR 91,50
AS 130.4	Test tube attachment	0003120300	EUR 217,00

Product	Description	Ident. No.	Price
ACCESSORIES KS HS 260 BASIC CONTROL AND KS 3000			
AS 260.1	Universal attachment	0008017400	EUR 538,00
AS 260.2	Fixing clip attachment	0003115500	EUR 138,00
AS 260.3	Dish attachment	0003120600	EUR 116,00
AS 260.5	Separating funnel attachment	0003120900	EUR 561,00

Product	Description	Ident. No.	Price
ACCESSORIES KS HS 501 DIGITAL			
AS 501.1	Universal attachment	0008000200	EUR 1.620,00
AS 501.2	Separating funnel attachment	0008000300	EUR 1.728,00
AS 501.3	Separating funnel attachment	0008000400	EUR 1.403,00
AS 501.4	Fixing clip attachment	0002341100	EUR 1.078,00
AS 501.5	Dish attachment	0002339600	EUR 215,00
AS 501.6	Separating funnel attachment	0008000500	EUR 2.485,00



AS 1.400

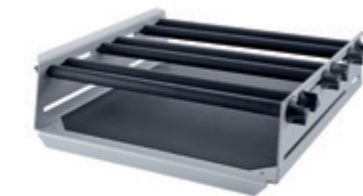

AS 4000.1



AS 1.30



AS 1.31



AS 1.7



AS 1.13



AS 2.1



AS 2.4



AS 2.6

Product	Description	Ident. No.	Price
ACCESSORIES KS 4000 IC CONTROL			
AS 4000.1	Universal attachment	0008022200	EUR 860,00
AS 4000.2	Fixing clip attachment	0003710100	EUR 718,00
AS 4000.3	Dish attachment	0003710000	EUR 188,00
AS 1.400	Basic holder for AS 4000.1	0003710200	EUR 492,00
AS 1.401	Clamping roll for AS 4000.1	0003712000	EUR 47,00
AS 1.402	Fastening screw for AS 4000.1	0003712300	EUR 7,20

Product	Description	Ident. No.	Price
ACCESSORIES			
AS 1.30	Basic holder for AS 130.1	0003148000	EUR 272,00
AS 1.60	Basic holder for AS 260.1	0003149000	EUR 492,00
AS 1.10	Basic holder for AS 501.1	0002339700	EUR 729,00
AS 1.31	Clamping roll for AS 130.1	0003030500	EUR 28,50
AS 1.61	Clamping roll for AS 260.1	0003030501	EUR 36,00
AS 1.11	Clamping roll for AS 501.1	0002339800	EUR 67,50
AS 1.6	Clamping device for AS 501.1	0001268400	EUR 46,00
AS 1.7	Clamping device for AS 501.1	0001269200	EUR 65,50
AS 1.12	Supporting bar for AS 1.10	0002594500	EUR 134,00
AS 1.13	Ground section holder for AS 1.10	0002597000	EUR 130,00
STICKMAX	Universal adhesive mat	0003920000	EUR 49,00
AS 2.0	Fixing clips, 10 ml	0020016475	EUR 44,00
AS 2.1	Fixing clips, 25 ml	0001234300	EUR 22,50
AS 2.2	Fixing clips, 50 ml	0001234400	EUR 22,50
AS 2.3	Fixing clips, 100 ml	0001234500	EUR 22,50
AS 2.4	Fixing clips, 200 250 ml	0001234600	EUR 44,00
AS 2.5	Fixing clips, 500 ml	0001234700	EUR 44,00
AS 2.6	Fixing clips, 1000 ml	0003819300	EUR 44,00
AS 2.7	Fixing clips, 2000 ml	0020016476	EUR 62,50



STICKMAX

IKA's ULTRA-TURRAX® – used for homogenizing, emulsifying or suspending. The digital display allows you to keep track of the speed and the development of the products focused on a soft start of the motor. There is a broad spectrum of dispersing tools to choose from. Common disperser applications include: homogenization of effluent samples, dispersing tasks under vacuum pressure, and PCR analysis.

T 25 EASY CLEAN DIGITAL AND CONTROL /// The new dispersing experience



More quiet, clean and even remote controlled: The T 25 easy clean high-performance disperser in the digital and control versions will change your dispersing experience. These instruments hit the spot with electronic speed control from 3000 – 25 000 rpm, a working volume of 1 – 2000 ml (water), a long service life both for the drive and tools, as well as a wide range of dispersing tools to choose from. Medical samples are perfectly homogenised, cosmetics emulsified and paints suspended.



ELECTRONICALLY COMMUTATED MOTOR
IKA applies a new motor technology to the devices in the T 25 easy clean series: The brushless DC motor, with a noise level of 70 dB, ensures a significant noise reduction in the lab. It also allows carbon dust-free operation.

EASY CLEANING
Easy clean means: The dispersing element is easily cleaned without disassembly, thanks to its manually extendable rotor.

INTEGRATED TEMPERATURE MEASUREMENT
Yet another highlight is the patented, integrated temperature measurement in the T 25 easy clean control version. The temperature sensor is integrated into the tool and thus enables the permanent monitoring of the medium temperature.

ULTRA-TURRAX® Tube Drive

EUR 649,00
Ident. No. 0003646000



ULTRA-TURRAX® Tube Drive P control Workstation

EUR 1.349,00
Ident. No. 0025005836



ULTRA-TURRAX® Tube Drive P control

EUR 1.299,00
Ident. No. 0025005981



TECHNICAL DATA

TECHNICAL DATA	UTTD® TUBE DRIVE	UTTD® TUBE DRIVE P CONTROL	UTTD® TUBE DRIVE P CONTROL WORKSTATION
Process type	Batch	Batch	Batch
Speed range	300 – 6000 rpm	400 – 8000 rpm	400 – 8000 rpm
Timer	–	OLED	OLED
Noise without element	50 dB(A)	50 dB(A)	50 dB(A)
Reversible direction of rotation	–	Yes	Yes
Viscosity max.	5000 mPas	5000 mPas	5000 mPas
Dimensions (W x H x D) Dimension case (W x H x D)	100 x 40 x 160 mm	122 x 54 x 178 mm	122 x 54 x 178 mm 270 x 78 x 225 mm
Protection class according to DIN EN 60529	IP 20	IP 20	IP 20



ST-20

ST-50-M

Product	Description	Ident. No.	Price
ST TUBES WITH STIRRING ELEMENT			
ST-20	Tube with stirring element, 20 ml, 25 pcs.	0003703000	EUR 178,00
ST-20-M-gamma	Tube with stirring element, sterile, 20 ml, 20 pcs.	0003700500	EUR 199,00
ST-50	Tube with stirring element, 50 ml, 10 pcs.	0003699500	EUR 88,00
ST-50-M-gamma	Tube with stirring element, sterile, 50 ml, 10 pcs., membrane lid	0003701500	EUR 139,00

Product	Description	Ident. No.	Price
DT TUBES WITH ROTOR-STATOR ELEMENT			
DT-20	Tube with rotor-stator element, 20 ml, 25 pcs.	0003703100	EUR 185,00
DT-20-M-gamma	Tube with rotor-stator element, sterile, 20 ml, 20 pcs.	0003700600	EUR 219,00
DT-20 eco	Tube with rotor-stator element, 20 ml, 25 pcs.	0020003207	EUR 159,00
DT-50	Tube with rotor-stator element, 50 ml, 10 pcs.	0003699600	EUR 99,00
DT-50-M-gamma	Tube with rotor-stator element, sterile, 50 ml, 10 pcs., membrane lid	0003701600	EUR 159,00
DT-50 eco	Tube with rotor-stator element, 50 ml, 10 pcs., membrane lid	0020003213	EUR 89,00



DT-20

DT-50-M

Product	Description	Ident. No.	Price
BMT G S TUBES FOR GRINDING WITH GLASS (G) OR STAINLESS STEEL (S) BALLS			
BMT-20-S	Tube with stirring element, stainless steel balls, 20 ml, 25 pcs.	0003703200	EUR 199,00
BMT-20-G	Tube with stirring element, glass balls, 20 ml, 25 pcs.	0003703300	EUR 199,00
BMT-20-S-M-gamma	Tube with stirring element, sterile, stainless steel balls, 20 ml, 20 pcs., membrane lid	0003700701	EUR 229,00
BMT-20-G-M-gamma	Tube with stirring element, sterile, glass balls, 20 ml, 20 pcs., membrane lid	0020017448	EUR 229,00
BMT-20-S-IVD.50	Tube with stirring element, sterile, IVD label, stainless steel balls, 5 ml NaCl solution, 20 ml, 50 pcs.	0020019573	EUR 675,00
BMT-50-S	Tube with stirring element, stainless steel balls, 50 ml, 10 pcs.	0003699700	EUR 119,00
BMT-50-G	Tube with stirring element, glass balls, 50 ml, 10 pcs.	0003699800	EUR 119,00
BMT-50-S-M-gamma	Tube with stirring element, sterile, stainless steel balls, 50 ml, 10 pcs., membrane lid	0003701700	EUR 169,00

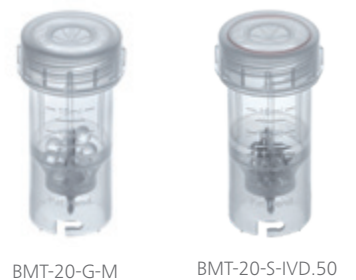

BMT-20-G-M

BMT-20-S-IVD.50

New accessory



DIS-50-S-M

DIS-300-S-M

Product	Description	Ident. No.	Price
TUBES WITH DISSOLVER ELEMENT AND MEMBRANE LID			
DIS-50-S-M	Tube with dissolver blade, 50 ml, 10 pcs., stainless steel	0020016316	EUR 99,00
DIS-50-T-M	Tube with dissolver blade, 50 ml, 10 pcs., titanium	0020016317	EUR 119,00
DIS-300-S-M.10	Tube with dissolver blade, 300 ml, 10 pcs., stainless steel	0020016318	EUR 149,00
DIS-300-S-M.50	Tube with dissolver blade, 300 ml, 50 pcs., stainless steel	0020017313	EUR 729,00



TC-20-M

TC-50-M

Product	Description	Ident. No.	Price
COVERS			
TC-20-M	Cover, pierceable membrane, 25 pcs.	0003749900	EUR 49,75
TC-50-M	Cover, pierceable membrane, 10 pcs.	0003750000	EUR 32,00
BALLS FOR BMT TUBE			
Glass balls 6	Glass balls, 250 g	0003599200	EUR 49,00
Stainless steel balls 5	Stainless steel balls, 250 g	0003599300	EUR 49,00



BMT-20-S-IVD

/// For use in human medicine

BMT-20-S-IVD* is a universally applicable disposable mixing vessel for use in human medicine and infection diagnostics. The gamma-sterilized tube contains a stirring unit, 10 stainless steel balls and 5 ml of saline solution and has a screw-on cover with pierceable membrane. BMT-20-S-IVD facilitates and improves microbiological and molecular-biological analysis of patient samples such as tissue or intraoperative samples.

REDUCED RISK OF CONTAMINATION

No cross-contamination as sample is directly ground inside the vessel, no multiple opening of sample vessel required.

TIME SAVING

Disposable system, shorter sample preparation times, no cleaning of additional vessels.

TRACEABILITY

One single process for transport, grinding / homogenization and storage.

*Currently released distribution countries are United Kingdom, Switzerland, Spain, Malta, Luxembourg, Liechtenstein, Italy, Ireland, Iceland, Germany, France, Estonia, Belgium, Austria.

T 10 basic ULTRA-TURRAX®

EUR 1.234,00
Ident. No. 0003737000



T 18 digital ULTRA-TURRAX®

EUR 1.337,00
Ident. No. 0003720000



T 25 digital ULTRA-TURRAX®

EUR 1.955,00
Ident. No. 0003725000



T 50 digital ULTRA-TURRAX®

EUR 3.112,00
Ident. No. 0003787000



TECHNICAL DATA	T 10 BASIC ULTRA-TURRAX®	T 18 DIGITAL ULTRA-TURRAX®	T 25 DIGITAL ULTRA-TURRAX®	T 50 DIGITAL ULTRA-TURRAX®
Process type	Batch	Batch	Batch	Batch
Speed range	8000 – 30 000 rpm	3000 – 25 000 rpm	3000 – 25 000 rpm	600 – 10 000 rpm
Volume range (H ₂ O)	0,0005 – 0,1 l	0,001 – 1,5 l	0,001 – 2,0 l	0,25 – 30 l
Speed control	Stepless	Stepless	Stepless	Stepless
Noise without element	65 dB(A)	75 dB(A)	75 dB(A)	72 dB(A)
Extension arm length	100 mm	160 mm	160 mm	220 mm
Viscosity max.	5000 mPas	5000 mPas	5000 mPas	5000 mPas
Dimensions (W x H x D)	56 x 178 x 66 mm	87 x 271 x 106 mm	87 x 271 x 106 mm	115 x 355 x 139 mm
Protection class according to DIN EN 60529	IP 30	IP 20	IP 20	IP 20

T 25 easy clean digital

EUR 2.058,00
Ident. No. 0025002560



T 25 easy clean control

EUR 2.367,00
Ident. No. 0025002500



Integrated temperature measurement

T 65 basic ULTRA-TURRAX®

EUR 4.736,00
Ident. No. 0004023500



T 65 digital ULTRA-TURRAX®

EUR 8.070,00
Ident. No. 0004234500



TECHNICAL DATA	T 25 EASY CLEAN DIGITAL CONTROL	T 65 BASIC ULTRA-TURRAX®	T 65 DIGITAL ULTRA-TURRAX®
Process type	Batch	Batch	Batch
Speed range	3000 – 25 000 rpm	7200 rpm	1000 – 9500 rpm
Volume range (H ₂ O)	0,001 – 2,0 l	2 – 50 l	2 – 50 l
Speed control	Stepless	–	Stepless
Noise without element	70 dB(A)	75 dB(A)	75 dB(A)
Extension arm length	160 mm		
Viscosity max.	5000 mPas	5000 mPas	5000 mPas
Dimensions (W x H x D)	89 x 270 x 161 mm	185 x 450 x 400 mm	300 x 390 x 400 mm
Protection class according to DIN EN 60529	IP 30	IP 54	IP 54

S 10 N - 10 G - ST



S 10 D - 7 G - KS - 65



S 18 D - 10 G - KS



S 18 N - 19 G



S 18 | 25 - ET50

Product	Description	Ident. No.	Price
DISPERSING ELEMENTS FOR T 10 BASIC			
S 10 N - 8 G - ST	Dispersing element, saw-tooth, Ø 8 mm	0004446500	EUR 1.299,00
S 10 N - 10 G - ST	Dispersing element, saw-tooth, Ø 10 mm	0004446700	EUR 1.299,00
S 10 N - 5 G	Dispersing element, Ø 5 mm	0003304000	EUR 1.199,00
S 10 N - 8 G	Dispersing element, Ø 8 mm	0003305500	EUR 1.199,00
S 10 N - 10 G	Dispersing element, Ø 10 mm	0003370100	EUR 1.199,00
S 10 D - 7 G - KS - 65	Plastic dispersing element, Ø 7 mm, 24 pcs.	0020002076	EUR 399,00
S 10 D - 7 G - KS - 110	Plastic dispersing element, Ø 7 mm, 24 pcs.	0020002075	EUR 449,00

Product	Description	Ident. No.	Price
DISPERSING ELEMENTS FOR T 18 DIGITAL			
S 18 N - 10 G	Dispersing element, Ø 10 mm	L004639	EUR 966,00
S 18 N - 19 G	Dispersing element, Ø 19 mm	L004640	EUR 966,00
S 18 D - 10 G - KS	Plastic dispersing element, Ø 10 mm, 12 pcs.	0003452400	EUR 239,00
S 18 D - 14 G - KS	Plastic dispersing element, Ø 14 mm, 12 pcs.	0003452300	EUR 239,00
S 18 25-ET50	Disposable tube	0003452500	EUR 5,00



S 25 N - 18 G - ST



S 25 KV 2802



S 25 KV - 25 F



S 25 D - 14 G - KS



S 25 KD - 25 G - ST

Product	Description	Ident. No.	Price
DISPERSING ELEMENTS FOR T 25 DIGITAL			
S 25 N - 8 G - ST	Dispersing element, saw-tooth, Ø 8 mm	0004446900	EUR 1.349,00
S 25 N - 10 G - ST	Dispersing element, saw-tooth, Ø 10 mm	0004447100	EUR 1.049,00
S 25 N - 18 G - ST	Dispersing element, saw-tooth, Ø 18 mm	0004447300	EUR 1.054,00
S 25 N - 25 G - ST	Dispersing element, saw-tooth, Ø 25 mm	0004447500	EUR 1.349,00
S 25 N - 8 G	Dispersing element, Ø 8 mm	0001024200	EUR 1.332,00
S 25 N - 10 G	Dispersing element, Ø 10 mm	0000594000	EUR 999,00
S 25 N - 18 G	Dispersing element, Ø 18 mm	0000593400	EUR 999,00
S 25 KV - 18 G	Dispersing element, Ø 18 mm	0002348000	EUR 1.899,00
S 25 N - 25 G	Dispersing element, Ø 25 mm	0001713300	EUR 1.277,00
S 25 KV - 25 G	Dispersing element, Ø 25 mm	0002466900	EUR 1.999,00
S 25 N - 25 F	Dispersing element, Ø 25 mm	0001713800	EUR 1.349,00
S 25 KV - 25 F	Dispersing element, Ø 25 mm	0002404000	EUR 2.099,00
S 25 KV - 2802	Dissolver stirrer, high speed	0020008825	EUR 1.935,00
S 25 D - 10 G - KS	Plastic dispersing element, Ø 10 mm, 12 pcs.	0003452200	EUR 239,00
S 25 D - 14 G - KS	Plastic dispersing element, Ø 14 mm, 12 pcs.	0003452100	EUR 239,00
S 25 KD - 18 G	Dispersing element, Ø 18 mm	0020002971	EUR 1.299,00
S 25 KD - 25 G	Dispersing element, Ø 25 mm	0020002972	EUR 1.555,00
S 25 KD - 18 G - ST	Dispersing element, saw-tooth, Ø 18 mm	0020002973	EUR 1.349,00
S 25 KD - 25 G - ST	Dispersing element, saw-tooth, Ø 25 mm	0020002974	EUR 1.610,00
S 25 KD - 25 F	Dispersing element, Ø 25 mm	0020002975	EUR 1.649,00
Silentstream	Flow breaker	0003754000	EUR 18,00
S 18 25-ET50	Disposable tube	0003452500	EUR 5,00
TS 25-3	Cleaning tool	0020003013	EUR 89,00
CT.15	Cleaning tube	0020006595	EUR 120,00



Silentstream



TS 25-3

Prevents
vortexing



S 25 EC - T - C - 25 F



S 50 KG - HH - G 45 G - ST



S 50 N - W 65 SK

Product	Description	Ident. No.	Price
DISPERSING ELEMENTS FOR T 25 EASY CLEAN DIGITAL AND CONTROL			
S 25 EC - T - C - 18 G - ST	Dispersing element, Ø 18 mm, temperature measurement	0020007032	EUR 1.440,00
S 25 EC - C - 25 G - ST	Dispersing element, Ø 25 mm	0025002590	EUR 1.286,00
S 25 EC - C - 25 F	Dispersing element, Ø 25 mm	0025007215	EUR 1.337,00
S 25 EC - C - 18 G - ST	Dispersing element, Ø 18 mm	0025002580	EUR 1.234,00
S 25 EC - T - C - 25 G - ST	Dispersing element, Ø 25 mm, temperature sensor	0025002595	EUR 1.492,00
S 25 EC - T - C - 25 F	Dispersing element, Ø 25 mm, temperature sensor	0025007199	EUR 1.543,00
HS 25 EC - DW	Holder S 25 EC for dish washer	0025007380	EUR 76,00
WICO	Wireless remote control	0025006310	EUR 569,00

Product	Description	Ident. No.	Price
DISPERSING ELEMENTS FOR T 50 DIGITAL			
S 50 KG - HH - G 45 G	Dispersing element, Ø 45 mm	0008003200	EUR 3.947,00
S 50 KG - HH - G 45 G - ST	Dispersing element, Ø 45 mm	0010000648	EUR 3.947,00
S 50 KG - HH - G 45 M	Dispersing element, Ø 45 mm	0008003500	EUR 4.208,00
S 50 KG - HH - G 45 F	Dispersing element, Ø 45 mm	0008004100	EUR 4.350,00
S 50 N - G 45 G	Dispersing element, Ø 45 mm	0008003000	EUR 2.606,00
S 50 N - G 45 M	Dispersing element, Ø 45 mm	0008003300	EUR 2.867,00
S 50 N - G 45 F	Dispersing element, Ø 45 mm	0008003900	EUR 3.009,00
S 50 N - G 45 G - ST	Dispersing element, saw-tooth, Ø 45 mm	0008039500	EUR 2.606,00
S 50 KD - G 45 G	Dispersing element, Ø 45 mm	0010000629	EUR 3.501,00
S 50 KD - G 45 G - ST	Dispersing element, saw-tooth, Ø 45 mm	0010000632	EUR 3.501,00
S 50 KD - G 45 M	Dispersing element, Ø 45 mm	0010000630	EUR 3.762,00
S 50 KD - G 45 F	Dispersing element, Ø 45 mm	0010000631	EUR 3.904,00
R 50	Stirring shaft, high speed	0001689300	EUR 1.899,00
R 1405	Propeller, Ø 45 mm	0001289800	EUR 184,00
R 1402	Dissolver, Ø 42 mm	0001243300	EUR 256,00
S 50 N - W 65 SK	Dispersing element with cutting head, Ø 65 mm	0008005100	EUR 2.923,00
S 50 N - W 80 SMK	Jet mixer head, Ø 80 mm	0008006300	EUR 2.735,00



S 65 C - G 65 G



S 65 KD - G 65 M



D 80

Product	Description	Ident. No.	Price
DISPERSING ELEMENTS FOR T 65 BASIC AND DIGITAL			
S 65 KG - HH - G 65 G	Dispersing element, Ø 65 mm	0008005500	EUR 3.954,00
S 65 KG - HH - G 65 M	Dispersing element, Ø 65 mm	0008005700	EUR 4.221,00
S 65 KG - HH - G 65 F	Dispersing element, Ø 65 mm	0008005900	EUR 4.384,00
S 65 C - G 65 G	Dispersing element, Ø 65 mm	0010001665	EUR 3.451,00
S 65 C - G 65 M	Dispersing element, Ø 65 mm	0010001666	EUR 3.718,00
S 65 C - G 65 F	Dispersing element, Ø 65 mm	0010001667	EUR 3.881,00
S 65 KD - G 65 G	Dispersing element, Ø 65 mm	0010000641	EUR 3.552,00
S 65 KD - G 65 M	Dispersing element, Ø 65 mm	0010000642	EUR 3.819,00
S 65 KD - G 65 F	Dispersing element, Ø 65 mm	0010000643	EUR 3.982,00
D 60	Dissolver, Ø 60 mm	0020008388	EUR 449,00
D 80	Dissolver, Ø 80 mm	0020008389	EUR 499,00

NOMENCLATURE DISPERSING ELEMENTS



- N** = PTFE bearing
- KV** = Ball bearing with vacuum-tight sliding-ring seal with silicon carbide seal rings
- NK** = PTFE bearing with additional ball bearing without seal
- KG - HH** = Ball bearing with sliding-ring seals of hard metal allow with FFPM seals rings
- B** = Bronze bearing
- KR** = Ball bearing with FKM or FFPM seal

IKA laboratory mills are ideal for grinding, pulverizing or chopping samples for routine analyses, either in batch or continuous operation. Grinding results are achieved up to 1 µm particle size or 0,25 mm defined ultimate fineness. Due to a broad spectrum of easily interchangeable beaters and cutters, IKA mills are highly effective for a variety of applications and can also be scaled up for larger volumes.

MULTIDRIVE BASIC AND CONTROL

/// The all-rounder in coarse and fine crushing



Regardless of whether samples are hard, soft or fibrous – the IKA MultiDrive blender can perform a wide range of crushing tasks involving coarse and fine crushing, thanks to the variety of vessels* available. With the MultiDrive basic it is possible to mix or grind; MultiDrive control is also fitted with a dispersion vessel and a disposable tube. There is a USB interface available for easy actuation and documentation respectively.

MultiDrive control

EUR 3.299,00
Ident. No. 0025002643

* Vessels don't belong to the scope of delivery.

HIGH PERFORMANCE

Excellent crushing performance is guaranteed by a combination of variable rotational speeds, ranging from 3000 rpm to 20 000 rpm, and a 1000 W output.

INTERVAL OPERATION

The option of interval programming is simple to activate at the press of a button. Interval operation is an asset during the coarse crushing of hard samples or for extra thorough blending.

INTEGRATED COOLING

A cooling system is integrated in the milling cup, which allows indirect heat dissipation. Thus, coolant and sample remain separate.

TEMPERATURE MEASUREMENT

MultiDrive control offers temperature measurement and vessel recognition using RFID. A temperature limit can be set for temperature-sensitive materials, or for specific planned reactions to protect against overheating.

WEIGHING FUNCTION

The weighing function is also integrated into the user-friendly workflow of the IKA MultiDrive control. Weighing is performed before crushing using the same mixing cup, so that no transfer of contents is required.

MultiDrive basic*

EUR 2.749,00
Ident. No. 0025002638

* Vessels don't belong to the scope of delivery.



MultiDrive basic M 20 Successor Package

EUR 3.408,00
Ident. No. 0010005893

> MultiDrive basic base unit
+ MI 250, 250 ml milling chamber



TECHNICAL DATA	MULTIDRIVE CONTROL	MULTIDRIVE BASIC
Operating principle	Cutting / Impact	Cutting / Impact
Speed range	3000 – 20 000 rpm	3000 – 20 000 rpm
Useable volume max.	2000 ml	2000 ml
Feed hardness max.	5 Mohs	5 Mohs
Temperature measurement	Yes	–
Weighing function	Yes	–
Milling chamber can be cooled with water / dry ice	Yes / Yes	Yes / Yes
Dimensions (W × H × D)	300 × 450 × 250 mm	300 × 450 × 250 mm
Protection class according to DIN EN 60529	IP 31	IP 31

A 10 basic

EUR 1.799,00
Ident. No. 0004020700



A 11 basic

EUR 2.161,00
Ident. No. 0002900000



M 20

EUR 5.999,00
Ident. No. 0001603600

For dry grinding of hard and brittle substances



MF 10 basic

EUR 4.118,00
Ident. No. 0002836000

Two different grinding heads can be attached to the drive, see Page 71

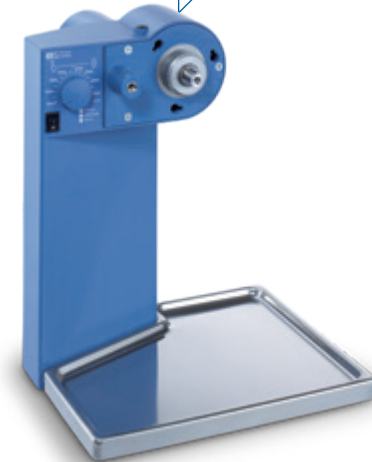

TECHNICAL DATA	A 10 BASIC	A 11 BASIC	M 20	MF 10 BASIC
Process type	Batch	Batch	Batch	Inline
Operating principle	Cutting / Impact	Cutting / Impact	Cutting / Impact	Cutting / Impact
Speed max.	25 000 rpm	28 000 rpm	20 000 rpm	3000 – 6500 rpm
Useable volume max.	50 ml	80 ml	250 ml	–
Feed hardness max.	5 Mohs	6 Mohs	5 Mohs	6 Mohs (MF 10.2)
Milling chamber, can be cooled with water / dry ice / liquid nitrogen	Yes / Yes / No	No / Yes / Yes	Yes / Yes / No	No / Yes / No
Dimensions (W x H x D)	130 x 250 x 145 mm	85 x 240 x 85 mm	170 x 350 x 170 mm	320 x 380 x 300 mm
Protection class according to DIN EN 60529	IP 41	IP 43	IP 21	IP 22

Tube Mill 100 control

EUR 2.058,00
Ident. No. 0020007144

Designed for grinding chambers with max. 100 ml



Tube Mill control

EUR 1.899,00
Ident. No. 0004180000



reddot design award winner 2013

German Design Award NOMINEE 2015



TECHNICAL DATA	TUBE MILL CONTROL	TUBE MILL 100 CONTROL
Process type	Batch	Batch
Operating principle	Cutting / Impact	Cutting / Impact
Speed max.	25 000 rpm	25 000 rpm
Circumferential speed max.	65 m/s	65 m/s
Useable volume max.	40 ml	100 ml
Feed hardness max.	5 Mohs	5 Mohs
Milling chamber, can be cooled with water / dry ice / liquid nitrogen	No / Yes / No	No / Yes / No
Dimensions (W x H x D)	180 x 170 x 300 mm	180 x 212 x 300 mm
Protection class according to DIN EN 60529	IP 30	IP 30



IKA MultiDrive BL 2000



IKA MultiDrive MI 250



MMT 40



MTT 40



MMT 100

Product	Description	Ident. No.	Price
ACCESSORIES MULTIDRIVE BASIC AND CONTROL			
MultiDrive BL 2000	Blender vessel, 2000 ml	0025003961	EUR 549,00
MultiDrive BL 2000 T	Blender vessel, 2000 ml, Temperature measurement	0025003962	EUR 659,00
MultiDrive MI 250	Milling chamber, 250 ml	0025003967	EUR 659,00
MultiDrive MI 400	Milling chamber, 400 ml	0025003965	EUR 769,00
MultiDrive MI 250 T	Milling chamber, 250 ml, Temperature measurement	0025003968	EUR 769,00
MultiDrive MI 400 T	Milling chamber, 400 ml, Temperature measurement	0025003966	EUR 879,00
MultiDrive DI 2000 T	Dispersing vessel, 2000 ml, Temperature measurement	0025003960	EUR 989,00
MultiDrive BL 2000.1	Standard blend knife, stainless steel	0020023169	EUR 119,00
MultiDrive MI 250.1	Standard beater, stainless steel	0020023166	EUR 69,00
MultiDrive MI 250.2	Star-shaped cutter, stainless steel	0020023167	EUR 139,00
MultiDrive MI 250.3	Beater, tungsten carbide	0020023168	EUR 299,00
MultiDrive MI 400.1	Standard beater, stainless steel	0020023170	EUR 89,00
MultiDrive MI 400.2	Star-shaped cutter, stainless steel	0020023171	EUR 159,00
MultiDrive MI 400.3	Beater, tungsten carbide	0020023172	EUR 329,00

ACCESSORIES TUBE MILL CONTROL

MT 40.10	Disposable grinding chamber, 40 ml, 10 pcs.	0004425000	EUR 69,00
MT 40.100	Disposable grinding chamber, 40 ml, 100 pcs.	0020001173	EUR 589,00
MTC 40/100.100	Cover for disposable grinding chamber, 100 pcs.	0020001182	EUR 49,00
MT 40.10 steril	Disposable grinding chamber, sterile, 40 ml, 10 pcs.	0020001984	EUR 119,00
MT 40 P.10	Disposable grinding chamber, bended beater, 40 ml, 10 pcs.	0020017838	EUR 79,00
MT 40 P.100	Disposable grinding chamber, bended beater, 40 ml, 100 pcs.	0020011531	EUR 689,00
MT 100.10	Disposable grinding chamber, 100 ml, 10 pcs.	0020008386	EUR 79,00
MT 100.10 steril	Disposable grinding chamber, sterile, 100 ml, 10 pcs.	0020012571	EUR 139,00
MT 100.50	Disposable grinding chamber, 100 ml, 50 pcs.	0020006984	EUR 349,00
MMT 40.1	Multi-use milling tube, 40 ml	0020003165	EUR 209,00
MMT 100.1	Multi-use milling tube, 100 ml	0020016315	EUR 229,00
MTT 40.10	Disposable grinding chamber, titanium beater, 40 ml, 10 pcs.	0020015380	EUR 119,00
MTT 100.10	Disposable grinding chamber, titanium beater, 100 ml, 10 pcs.	0020019576	EUR 139,00
A-MMT.100	Abrasion set for MMT 40.1 MMT 100.1, 100 sealing, 5 beaters, 5 couplings	0020003378	EUR 139,00

Product	Description	Ident. No.	Price
ACCESSORIES A 10 BASIC			
A 10.1	Stainless steel cutter	0025001680	EUR 45,00
A 10.2	Star-shaped cutter	0025001162	EUR 129,00
A 10.3	Hard metal cutter	0025001161	EUR 249,00
A 10.4	Grinding chamber reduction	0025001664	EUR 99,00

ACCESSORIES A 11 BASIC

A 11.1	Spare beater, stainless steel	0002904600	EUR 95,00
A 11.2	Cutting blade, stainless steel	0002905200	EUR 159,00
A 11.3	Beater, stainless steel	0002983000	EUR 199,00
A 11.4	Grinding chamber, polycarbonate, 250 ml	0002904100	EUR 539,00
A 11.5	Spare grinding chamber, Tefcel, 80 ml	0002983100	EUR 399,00
A 11.6	Double beater, titanium	0003302900	EUR 429,00
A 11.7	Funnel, PTFE	0003048700	EUR 219,00

ACCESSORIES M 20

M 21	Spare cutter, stn. steel	0000328200	EUR 79,00
M 22	Hard metal cutter, tungsten carbide	0000521800	EUR 329,00
M 23	Star-shaped cutter, stn. steel	0001443400	EUR 159,00
M 20.1	Grinding chamber, 250 ml	0008006200	EUR 3.527,00

ACCESSORIES MF 10 BASIC

MF 10.1	Cutting-grinding head	0002870900	EUR 3.245,00
MF 10.2	Impact-grinding head	0002871000	EUR 2.899,00

SIEVES

MF 0.25	Sieve, Ø 0,25 mm	0002938900	EUR 399,00
MF 0.5	Sieve, Ø 0,5 mm	0002939000	EUR 299,00
MF 1.0	Sieve, Ø 1 mm	0002939200	EUR 289,00
MF 2.0	Sieve, Ø 2 mm	0002939400	EUR 279,00
MF 3.0	Sieve, Ø 3 mm	0002939500	EUR 269,00
MF 4.0	Sieve, Ø 4 mm	0002939600	EUR 259,00



A 10.3



A 11.2



A 11.6



M 23



MF 10.1



MF 10.2



MF 0.25



MF 1.0



MF 4.0

Display viscosity even during product development: the new IKA STARVISC measuring stirrers make it possible. The devices have a broad range of applications and are particularly helpful during product development: STARVISC already clearly indicates while running research programmes as to whether the stirred substance can be used as desired.

STARVISC 200-2.5 CONTROL

/// The only device that can do everything at the same time



HIGH-PRECISION MEASUREMENT

STARVISC measures in a highly precise way and does this even during the manufacturing process. Samples no longer have to be taken separately.

VISCOSITY CALCULATION

A viscosity calculation can be carried out immediately via an user-friendly menu.

REMOVABLE CONTROL UNIT

The modern TFT display is removable. This means that STARVISC can also be controlled from a safe distance.

POWERFUL STIRRER

Even highly viscous substances can be intensively stirred using the powerful STARVISC stirrer. Quantities of up to 100 liters can be processed.

STARVISC 200-2.5 control

EUR 5.486,00

Ident. No. 0025003604



TECHNICAL DATA	STARVISC 200-2.5 CONTROL
Stirring quantity max. (H ₂ O)	100 l
Torque max. at stirring shaft	200 Ncm
Torque I max.	200 Ncm
Torque II max.	40 Ncm
Speed range I (high torque)	0 6 – 400 rpm
Speed range II (high speed)	0 30 – 2000 rpm
Display	TFT
Viscosity max.	100 000 mPas
Dimensions (W × H × D)	91 × 395 × 231 mm
Protection class according to DIN EN 60529	IP 40

Name	Description	Ident. No.	Price
------	-------------	------------	-------

ACCESSORIES STARVISC 200-2.5 CONTROL

STIRRING ELEMENTS

R 1302	Dissolver stirrer, Ø 100 mm	0002387900	EUR 499,00
R 1330	Anchor stirrer, Ø 45 mm	0002022300	EUR 339,00
R 1331	Anchor stirrer, Ø 90 mm	0002022400	EUR 410,00
R 1345	Propeller stirrer, 4-bladed, Ø 100 mm	0000741300	EUR 163,00
R 1375	Paddle stirrer, Ø 70 mm	0000757700	EUR 159,00

BOSS HEAD CLAMPS

R 270	Boss head clamp, clamping range Ø 25 – 36 mm	0002657800	EUR 104,00
R 271	Boss head clamp, clamping range Ø 34 mm	0002664000	EUR 168,00

STANDS

R 2722	H-stand, 1010 mm	0001412000	EUR 655,00
R 2723	Telescopic stand, H 620 – 1010 mm	0001412100	EUR 1.214,00

SOFTWARE

labworldsoft® 6 Starter	For configurations up to 3 devices	0020019397	EUR 4.017,00
labworldsoft® 6 Pro	For all configurations – any no. of devices can be controlled at the same time	0020017366	EUR 9.167,00

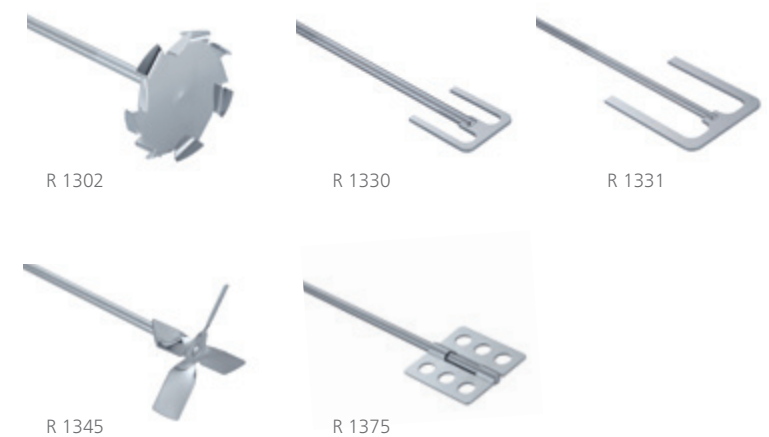

The ROTAVISC series determines the viscosity of liquids in all areas of application ranging from the laboratory to quality control. The four devices measure in different viscosity ranges. Regardless of a simple or demanding viscosity measurement – ROTAVISC delivers rapid and accurate results.

ROTAVISC

/// With the largest range of functions in its class

EASY TO OPERATE

The generous 4,3" TFT display allows for an intuitive menu guidance. A digital spirit level also supports the correct set-up of the start-up condition. The simple ramp function simplifies repetitive tasks.

HIGHEST MEASUREMENT ACCURACY

The level of measurement accuracy of the ROTAVISC rotational viscometer for both Newtonian and non-Newtonian fluids is +/- 1 % of the measuring range. The repeatability is +/- 0,2 %.

STEPLESS SPEED

ROTAVISC is a viscometer, which offers stepless speed adjustment.

SCOPE OF DELIVERY

The package includes a standard spindle set, a protective bracket, temperature sensor, quick connector, hook connector and ROTASTAND stand. Advanced packages additionally include software.



- | | |
|---|--|
| ① ROTAVISC lo-vi Complete
EUR 2.858,00
Ident. No. 0025000310 | ② ROTAVISC me-vi Complete
EUR 2.858,00
Ident. No. 0025000311 |
| ③ ROTAVISC hi-vi I Complete
EUR 2.858,00
Ident. No. 0025000312 | ④ ROTAVISC hi-vi II Complete
EUR 2.858,00
Ident. No. 0025000313 |
| ⑤ ROTAVISC lo-vi Advanced
EUR 3.573,00
Ident. No. 0025000320 | ⑥ ROTAVISC me-vi Advanced
EUR 3.573,00
Ident. No. 0025000321 |
| ⑦ ROTAVISC hi-vi I Advanced
EUR 3.573,00
Ident. No. 0025000322 | ⑧ ROTAVISC hi-vi II Advanced
EUR 3.573,00
Ident. No. 0025000323 |

Advanced packages include software



* After device registration on www.ika.com/register

TECHNICAL DATA	ROTAVISC
Viscosity accuracy	± 1 % FSR
Viscosity repeatability	0,2 % FSR
Display	TFT
Working temperature	Min.: -100 °C Max.: +300 °C
Speed	0,01 – 200 rpm
Speed setting accuracy	in range 0,01 – 1: 0,01 rpm in range 1 – 200: 0,1 rpm
Temperature measurement resolution	0,1 K
Connection for ext. temperature sensor	PT 100
Interfaces	USB, RS 232,
Dimensions (W x H x D)	351 x 629 x 372 mm
Weight	7,1 kg
Protection class according to DIN EN 60529	IP 40

MEASURING RANGES

ROTAVISC lo-vi

Viscosity measuring range 1 – 6 000 000 mPas

ROTAVISC me-vi

Viscosity measuring range 100 – 40 000 000 mPas

ROTAVISC hi-vi I

Viscosity measuring range 200 – 80 000 000 mPas

ROTAVISC hi-vi II

Viscosity measuring range 800 – 320 000 000 mPas



DINS-1



ELVAS-1



VOLS-1



VAN-1



BH 600

Product	Description	Ident. No.	Price
ADAPTERS			
DINS-1	DIN adapter set	0025000387	EUR 1.918,00
O DIN S-1	Open DIN adapter set	0025000326	EUR 1.918,00
SAS-1	Spiral adapter set	0025000377	EUR 1.010,00
ELVAS-1	Extremely low viscosity adapter set	0025000390	EUR 1.269,00
VOLS-1	Low volume adapter set	0025000352	EUR 1.089,00
SPINDLES			
VAN-1	Vane spindle set	0025000407	EUR 936,00
SP set-1	Standard spindle set (SP1 - SP4)	0025000319	EUR 191,00
SP set-2	Standard spindle set (SP7 - SP12)	0025000329	EUR 161,00
SP-6	Standard spindle	0025006833	EUR 129,00
SP-5	Standard spindle	0025006832	EUR 129,00
VOL-SP-7.1	Spindle for VOLS-1, 7,1 ml	0025006849	EUR 294,00
VOL-SP-16.1	Spindle for VOLS-1, 16,1 ml	0025006848	EUR 302,00
VOL-SP-10.4	Spindle for VOLS-1, 10,4 ml	0025006850	EUR 302,00
VOL-SP-11	Spindle for VOLS-1, 11 ml	0025006851	EUR 302,00
VOL-SP-13.5	Spindle for VOLS-1, 13,5 ml	0025006852	EUR 302,00
VOL-SP-9	Spindle for VOLS-1, 9 ml	0025006846	EUR 302,00
VOL-SP-9.4	Spindle for VOLS-1, 9,4 ml	0025006847	EUR 302,00
VOL-SP-2.1	Spindle for 2,1 ml chamber	0025007061	EUR 302,00
VOL-C-RTD-2.1	2,1 ml chamber for VOLS-1	0025007064	EUR 329,00
VOL-SP-3.8	Spindle for 3,8 ml chamber	0025007062	EUR 302,00
VOL-C-RTD-3.8	3,8 ml chamber for VOLS-1	0025007065	EUR 329,00
VOL-SP-4.2	Spindle for 4,2 ml chamber	0025007063	EUR 302,00
VOL-C-RTD-4.2	4,2 ml chamber for VOLS-1	0025007066	EUR 329,00
BH 600	Clamp for 600 ml beaker	0025000400	EUR 129,00
DWB 600	Double-walled beaker 600 ml	0020024575	EUR 698,00



CAL-O-5



CAL-O-100000

Product	Description	Ident. No.	Price
STANDARD SILICONE OILS			
CAL-O-5	Standard silicone oil, 5 mPas, 25 °C, 500 ml	0025000397	EUR 124,00
CAL-O-10	Standard silicone oil, 10 mPas, 25 °C, 500 ml	0025000398	EUR 124,00
CAL-O-50	Standard silicone oil, 50 mPas, 25 °C, 500 ml	0025000399	EUR 124,00
CAL-O-100	Standard silicone oil, 100 mPas, 25 °C, 500 ml	0025000434	EUR 124,00
CAL-O-500	Standard silicone oil, 500 mPas, 25 °C, 500 ml	0025000435	EUR 124,00
CAL-O-1000	Standard silicone oil, 1000 mPas, 25 °C, 500 ml	0025000436	EUR 124,00
CAL-O-5000	Standard silicone oil, 5000 mPas, 25 °C, 500 ml	0025000437	EUR 124,00
CAL-O-12500	Standard silicone oil, 12 500 mPas, 25 °C, 500 ml	0025000466	EUR 124,00
CAL-O-30000	Standard silicone oil, 30 000 mPas, 25 °C, 500 ml	0025000467	EUR 124,00
CAL-O-60000	Standard silicone oil, 60 000 mPas, 25 °C, 500 ml	0025000468	EUR 124,00
CAL-O-100000	Standard silicone oil, 100 000 mPas, 25 °C, 500 ml	0025000469	EUR 124,00
SOFTWARE			
labworldsoft® 6 Starter	Laboratory software	0020019397	EUR 4.017,00
labworldsoft® 6 Pro	Laboratory software	0020017366	EUR 9.167,00

IKA's small but excellent product group of vacuum pumps is perfectly suitable for many dry and oil-free applications in the laboratory. The devices stand out due to their high suction capacity and ease of service. Their membranes are particularly chemical resistant, as well. The diaphragm vacuum pumps are suitable for many vacuum tasks in the lab such as separation, filtration or degassing. They are even suitable to construct a laboratory vacuum system in which you can switch any number of vacuum controllers in series according to the application. In addition, they perfectly complement rotary evaporators or laboratory reactors.

VACSTAR DIGITAL AND CONTROL

/// Fully automatic vacuum with an emission condenser

Separation, filtration, removal: The VACSTAR dry 4-chamber membrane vacuum pump is powerful, resistant to chemicals and low-maintenance.

HIGH-PERFORMANCE SUCTION
VACSTAR has an excellent suction performance, with its 22 l/min at a minimum of 2 mbar.

INTEGRATED VACUUM CONTROLLER WITH REMOVABLE WIRELESS CONTROLLER (WiCo)

PROTECTS USER AND ENVIRONMENT
The VACSTAR control includes a downstream vacuum safety emission condenser (VSE1). This reliably protects laboratory employees and the environment from harmful exhaust air.



VACSTAR digital

EUR 2.154,00

Ident. No. 0020016236

VACSTAR control

EUR 4.050,00

Ident. No. 0020019065

Automatic cleaning function for increased service life



TECHNICAL DATA

	VACSTAR DIGITAL VACSTAR CONTROL
Maximum pumping capacity	22 l/min
Boiling point detection	No Yes
Solvent library	No Yes
Speed range	285 – 1200 rpm
Vacuum sensor	No Yes
Min. input pressure	2 mbar
Max. input pressure	1030 mbar
Dimensions (W x H x D)	150 x 375 x 370 mm 270 x 435 x 500 mm
Protection class acc. to DIN EN 60529	IP 20
RS 232 interface	Yes
USB interface	Yes
Voltage	100 – 240 V

Product	Ident. No.	Price
---------	------------	-------

ACCESSORIES VACSTAR DIGITAL AND CONTROL

VSW 1 vacuum safety woulff bottle	0020015406	EUR 398,00
VSE 1 vacuum safety emission	0035001873	EUR 441,00
VH.SI.8 vacuum hose, silicone, Ø 8 mm, 1 m	0020013886	EUR 33,50



VSW 1

VSE 1

MVP 10 basic

EUR 1.563,00

Ident. No. 0003980000

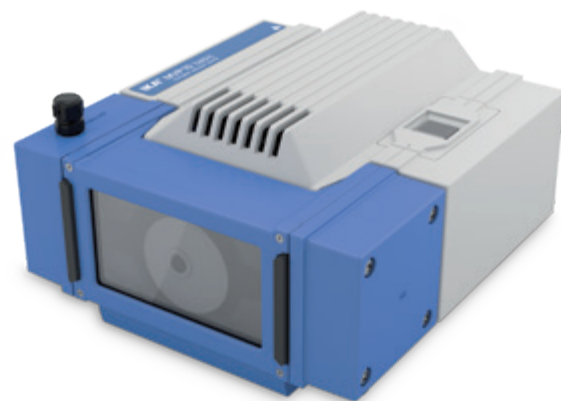
**TECHNICAL DATA**

TECHNICAL DATA	MVP 10 BASIC
Maximum pumping capacity	28,3 l/min
Speed range	1380 – 1680 rpm
Vacuum sensor	No
Min. input pressure	7 mbar
Max. input pressure	1050 mbar
Dimensions (W x H x D)	245 x 155 x 320 mm
Protection class acc. to DIN EN 60529	IP 54
Voltage	230 / 115 / 100 V

Product	Ident. No.	Price
ACCESSORIES MVP 10 BASIC		
VCV 1 vacuum control valve manual	0020004850	EUR 551,00
VCV 2 vacuum control valve digital	0020004893	EUR 913,00
VSS 1 vacuum safety set	0020005194	EUR 771,00
VH.SI.8 vacuum hose, silicone, Ø 8 mm, 1 m	0020013886	EUR 33,50



VCV 1



VSS 1

Product	Ident. No.	Price
ACCESSORIES VACUUM CONTROLLER		
VC 10.300 check valve	0020011105	EUR 161,00
VC 10.400 table holder	0035001735	EUR 198,00



VC 10.300

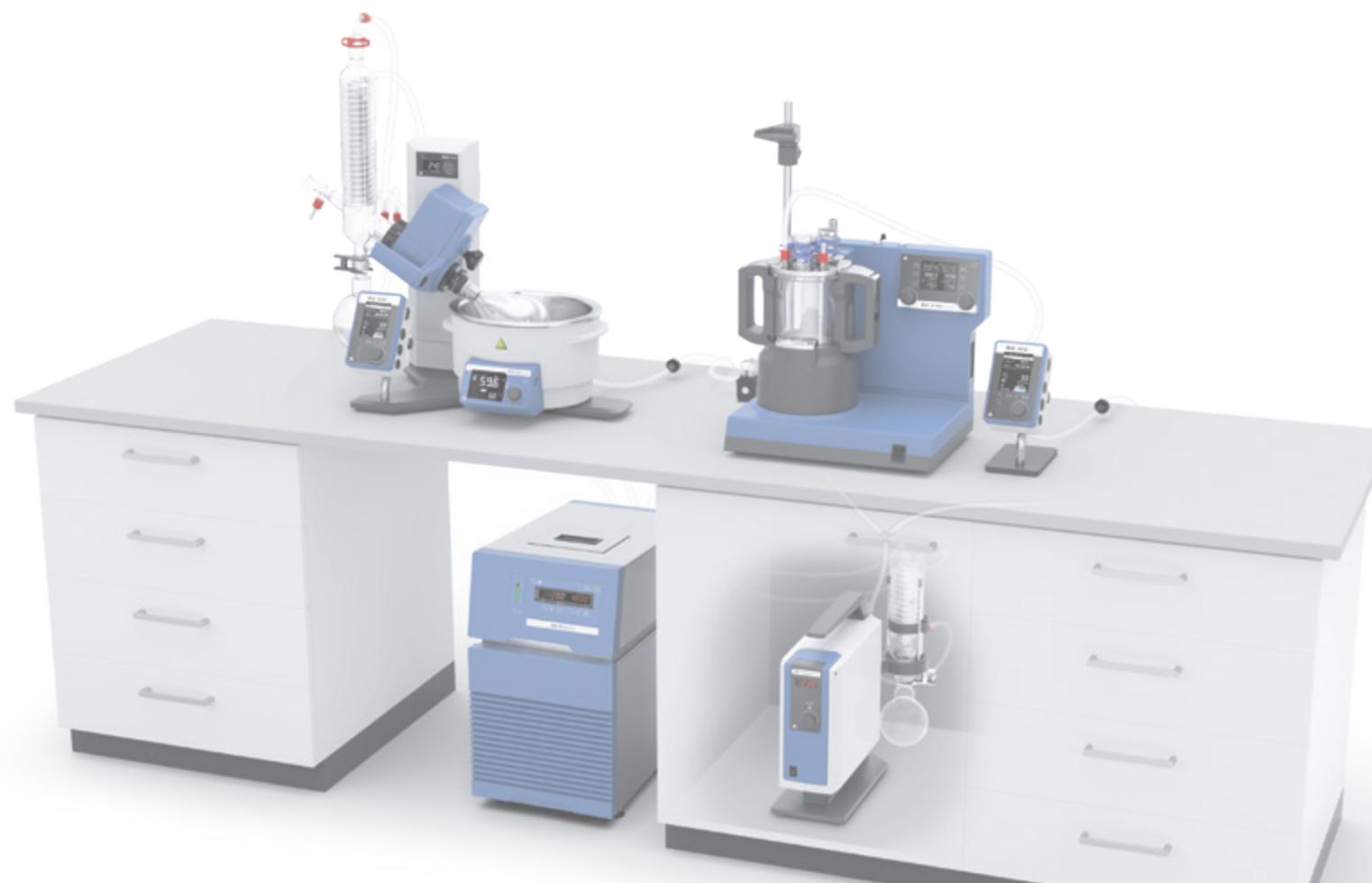

VC 10.400

**VC 10**

EUR 1.546,00

Ident. No. 0020005132

**TECHNICAL DATA**

TECHNICAL DATA	VC 10
Vacuum sensor	Yes
Min. input pressure	1 mbar
Max. input pressure	1050 mbar
Boiling point detection	Yes
Solvent library	Yes
Two-point control	Yes
Dimensions (W x H x D)	95 x 150 x 110 mm
Protection class acc. to DIN EN 60529	IP 20
RS 232 interface	Yes
USB interface	Yes
Voltage	100 – 240 V

Regardless of what leaves laboratory staff hot or cold, precise and constant temperature regulation is a basic prerequisite for successful applications in day-to-day laboratory practice. IKA strives to make your work with circulation and immersion thermostats or bridge and heating bath thermostats as pleasant and successful as possible. Our broad range of DIN 12876-compliant devices is designed for temperatures from -30 to 250 °C and meets the highest requirements of precision, safety, output and intelligence.

RC 2 GREEN

/// 1000 times more environmentally-friendly and yet more powerful

The new RC 2 green recirculating chiller is not only more environmentally-friendly by a factor of 1000, it also offers double cooling capacity than its smaller brother RC 2 basic.

NEW IN
Q3 | 2020



ENVIRONMENTALLY-FRIENDLY REFRIGERANT
RC 2 green operates with propan (R290). This natural refrigerant significantly increases the efficiency of the chiller and at the same time reduces the global warming potential factor (GWP) by a factor of > 400. Both the RC 2 green basic and the control variant also exhibit an outstanding cooling capacity down to -30 °C in this regard.

POWERFUL PUMP
With the 0,5 bar strong pressure and suction pump, the RC 2 green enables fast and reliable circulation of the coolant for the best possible cooling of your application.

STAINLESS STEEL FILTER
A new finely-woven stainless steel filter keeps the condenser clean during dissipation of heat and thus ensures that the thermostat's high level of performance is guaranteed for an even longer period. The filter can be easily installed, removed and cleaned.

MODERN DESIGN
RC 2 green was designed using the typical IKA user-friendly design approach. The modern display is easy to read and, in the control variant, has the intuitive IKA menu guide.

ICC basic

EUR 910,00
Ident. No. 0004134400



ICC control

EUR 1.499,00
Ident. No. 0004136600



IC basic

EUR 2.299,00
Ident. No. 0003861000

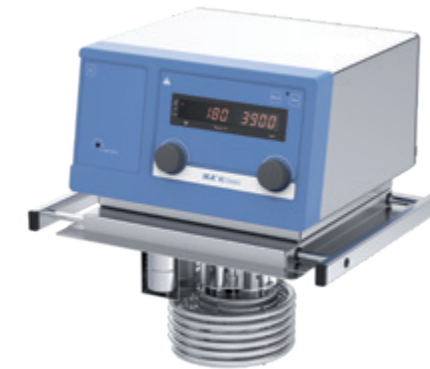

IC control

EUR 2.949,00
Ident. No. 0003863000***

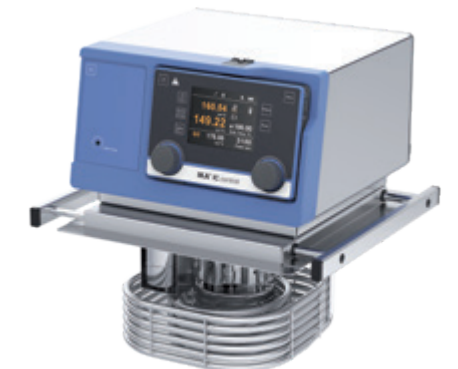

TECHNICAL DATA	ICC BASIC	ICC CONTROL	IC BASIC	IC CONTROL
Appliance type	Compact immersion circulator	Compact immersion circulator	Immersion circulator	Immersion circulator
Heat output (230 / 115 V)	2000 / 1000 W	2000 / 1000 W	2500 / 1250 W	2500 / 1250 W
Temperature range	RT +10 °C* – 150 °C	RT +10 °C* – 150 °C	RT +10 °C – 250 °C**	RT +10 °C – 250 °C**
Temperature display	LED	TFT	LED	TFT
Temperature stability DIN 12876	± 0,02 K	± 0,01 K	± 0,02 K	± 0,01 K
Max. flow rate	18 l/min	18 l/min	31 l/min	31 l/min
Max. pump pressure	0,3 bar	0,3 bar	0,61 bar	0,61 bar
Min. suction pressure	0,2 bar	0,2 bar	0,45 bar	0,45 bar
Dimensions (W × H × D)	145 × 340 × 200 mm	145 × 340 × 200 mm	285 × 313 × 291 mm	285 × 313 × 291 mm

* Possible operating temperatures with cooling coil: -20 °C to 150 °C

** Possible operating temperatures with cooling coil: -20 °C to 250 °C

*** CC 1 cooling coil included in delivery



ICC basic eco 8



ICC control pro 12

Product	Description	Bath size	Bath opening (W x D)***	Ident. No.	Price
HEATING BATH CIRCULATORS					
ICC basic eco* 8	Package ICC basic, 8 l eco bath	S	188 x 105 mm	0008034900	EUR 1.299,00
ICC basic pro** 9	Package ICC basic, 9 l pro bath	S	195 x 100 mm	0008035100	EUR 1.439,00
ICC basic pro 12	Package ICC basic, 12 l pro bath	M	255 x 127 mm	0010000414	EUR 1.499,00
ICC basic eco 18	Package ICC basic, 18 l eco bath	L	245 x 305 mm	0008035000	EUR 1.449,00
ICC basic pro 20	Package ICC basic, 20 l pro bath	L	255 x 309 mm	0008035200	EUR 1.599,00
ICC control eco 8	Package ICC control, 8 l eco bath	S	188 x 105 mm	0008035300	EUR 1.899,00
ICC control pro 9	Package ICC control, 9 l pro bath	S	195 x 100 mm	0008035500	EUR 1.999,00
ICC control pro 12	Package ICC control, 12 l pro bath	M	255 x 127 mm	0010000415	EUR 2.099,00
ICC control eco 18	Package ICC control, 18 l eco bath	L	245 x 305 mm	0008035400	EUR 2.029,00
ICC control pro 20	Package ICC control, 20 l pro bath	L	255 x 309 mm	0008035600	EUR 2.199,00
COMBINED HEATING BATH CIRCULATORS					
ICC basic eco 8 c	Package ICC basic, 8 l eco bath, cover	S	188 x 105 mm	0008035700	EUR 1.699,00
ICC basic pro 9 c	Package ICC basic, 9 l pro bath, cover	S	195 x 100 mm	0008035900	EUR 1.799,00
ICC basic pro 12 c	Package ICC basic, 12 l pro bath, cover	M	255 x 127 mm	0010000416	EUR 1.899,00
ICC basic eco 18 c	Package ICC basic, 18 l eco bath, cover	L	245 x 305 mm	0008035800	EUR 1.849,00
ICC basic pro 20 c	Package ICC basic, 20 l pro bath, cover	L	255 x 309 mm	0008036000	EUR 2.019,00
ICC control eco 8 c	Package ICC control, 8 l eco bath, cover	S	188 x 105 mm	0008036100	EUR 2.499,00
ICC control pro 9 c	Package ICC control, 9 l pro bath, cover	S	195 x 100 mm	0008036300	EUR 2.649,00
ICC control eco 18 c	Package ICC control, 18 l eco bath, cover	L	245 x 305 mm	0008036200	EUR 2.699,00
ICC control pro 12 c	Package ICC control, 12 l pro bath, cover	M	255 x 127 mm	0010000417	EUR 2.749,00
ICC control pro 20 c	Package ICC control, 20 l pro bath, cover	L	255 x 309 mm	0008036400	EUR 2.849,00
PACKAGES WITH MAGNETIC STIRRER					
ICC basic IB R RO 15 eco	Package ICC basic with magnetic stirrer RO 15 and bath	L	317 x 492 mm	0010002471	EUR 3.399,00
ICC control IB R RO 15 eco	Package ICC control with magnetic stirrer RO 15 and bath	L	317 x 492 mm	0010002474	EUR 3.999,00

* eco: plastic bath

** pro: stainless steel bath

*** Size of plate that can be placed at the bottom of the bath



ICC control pro 20 c

ICC basic IB R RO 15 eco
(Circulating bath with 15 stirring positions
for glass beakers up to 250 ml)

IC basic pro 12 c

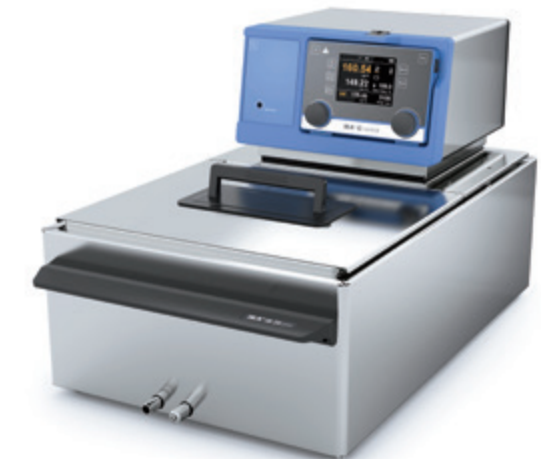

IC control pro 20 c

Product	Description	Bath size	Bath opening (W x D)***	Ident. No.	Price
IMMERSION CIRCULATOR PACKAGES					
IC basic pro 12 c	Package IC basic, 12 l pro bath, cover	M	255 x 80 mm	0008039900	EUR 3.349,00
IC basic pro 20 c	Package IC basic, 20 l pro bath, cover	L	255 x 262 mm	0008036800	EUR 3.499,00
IC control pro 12 c	Package IC control, 20 l pro bath, cover	M	255 x 80 mm	0008040000	EUR 3.949,00
IC control pro 20 c	Package IC control, 12 l pro bath, cover	L	255 x 262 mm	0008037200	EUR 4.099,00

*** Size of plate that can be placed at the bottom of the bath

/// Heating Bath Circulators

① HBC 5 basic

EUR 2.899,00
Ident. No. 0004125000

①



① HBC 10 basic

EUR 3.099,00
Ident. No. 0004135000

①



② HBC 5 control

EUR 3.549,00
Ident. No. 0004127000

② HBC 10 control

EUR 3.749,00
Ident. No. 0004137000

②



/// Refrigerated and Heating Bath Circulators

① CBC 5 basic

EUR 4.600,00
Ident. No. 0004165000

①



① HRC 2 basic

EUR 3.749,00
Ident. No. 0025003742

①



② CBC 5 control

EUR 5.304,00
Ident. No. 0004167000

② HRC 2 control

EUR 4.590,00
Ident. No. 0025004524

②

TECHNICAL DATA	HBC 5 BASIC CONTROL	HBC 10 BASIC CONTROL	CBC 5 BASIC CONTROL	HRC 2 BASIC CONTROL
Appliance type	Heated bath circulator	Heated bath circulator	Refrigerated and heating bath circulator	Refrigerated and heating bath circulator
Heater capacity (230 / 115 V)	2500 / 1250 W	2500 / 1250 W	2500 / 1250 W	1500 / 1200 W
Temperature range	RT + 10 °C* – 250 °C	RT + 10 °C* – 250 °C	-25 °C – 200 °C	-20 °C – 100 °C -30 °C** – 100 °C
Cooling capacity at 20 °C	–	–	350 W	400 W
Temperature display	LED TFT	LED TFT	LED TFT	LED TFT
Temperature stability DIN 12876	± 0,02 K ± 0,01 K	± 0,02 K ± 0,01 K	± 0,02 K ± 0,01 K	± 0,1 K ± 0,05 K
Max. flow rate	31 l/min	31 l/min	31 l/min	21 l/min
Max. pump pressure	0,61 bar	0,61 bar	0,61 bar	0,5 bar
Min. suction pressure	0,45 bar	0,45 bar	0,45 bar	0,25 bar
Dimensions (W × H × D)	275 × 406 × 500 mm	275 × 456 × 500 mm 275 × 456 × 506 mm	275 × 690 × 490 mm	220 × 475 × 525 mm

* Possible operating temperatures with cooling coil: -20 °C to 250 °C

** -30 °C possible at 2000 rpm

RC 2 basic

EUR 3.099,00
Ident. No. 0004171000



RC 2 control

EUR 3.999,00
Ident. No. 0004173000



BESTSELLER

RC 5 basic

EUR 4.599,00
Ident. No. 0004181000



RC 5 control

EUR 5.249,00
Ident. No. 0004183000



TECHNICAL DATA	RC 2 BASIC	RC 2 CONTROL	RC 5 BASIC	RC 5 CONTROL
Appliance type	Recirculating chiller	Recirculating chiller	Recirculating chiller	Recirculating chiller
Cooling capacity at 20 °C	400 W	400 W	1400 W	1400 W
Temperature range	-20 °C – RT	-30 °C – RT	-30 °C – RT	-30 °C – RT
Temperature display	LED	TFT	LED	TFT
Temperature stability DIN 12876	± 0,1 K	± 0,05 K	± 0,2 K	± 0,1 K
Max. flow rate	18 l/min	18 l/min	31 l/min	31 l/min
Max. pump pressure	0,3 bar	0,3 bar	0,61 bar	0,61 bar
Min. suction pressure	0,2 bar	0,2 bar	0,45 bar	0,45 bar
Dimensions (W × H × D)	220 × 475 × 525 mm	220 × 475 × 525 mm	310 × 546 × 490 mm	310 × 546 × 490 mm



CS.ICC

CL.ICC



BS.ICC

PCS.ICC



BS.IC

CC1



IB 8 eco

IB 18 eco



IB 9 pro

IB 20 pro

Product	Description	Ident. No.	Price
ACCESSORIES FOR ICC			
CS.ICC	Cover, small for ICC, 8 / 9 l bath vessels	0004471500	EUR 120,00
CM.ICC	Cover, medium for ICC, 12 l bath vessels	0025000290	EUR 150,00
CL.ICC	Cover, big for ICC, 18 / 20 l bath vessels	0004471600	EUR 170,00
CLG.ICC	Gable lid for ICC, bath size L	0020023680	EUR 490,00
CLR.ICC	Cover with 6 ring openings for ICC, 18/20 l bath vessels	0025006276	EUR 250,00
BS.ICC	Bridge, small for ICC, 8 / 9 l bath vessels	0020003077	EUR 120,00
BL.ICC	Bridge, big for ICC, 18 / 20 l bath vessels	0020003078	EUR 125,00
CC2	Cooling coil for ICC	0025001061	EUR 120,00
PCS.ICC	Pump connection set for ICC	0004471900	EUR 140,00

ACCESSORIES FOR IC

CM.IC	Cover, medium for IC, 12 l bath vessels	0004577600	EUR 123,00
CL.IC	Cover, big for IC, 18 / 20 l bath vessels	0004471800	EUR 164,00
BS.IC	Bridge, small for IC, 12 / 18 / 20 l bath vessels	0004472800	EUR 123,00
CC1	Cooling coil for IC basic / control	0020005116	EUR 128,00

BATH VESSELS**Bath size S**

IB 8 eco	Bath vessel, plastic, 8 l	0004248100	EUR 330,00
IB R 9 eco	Bath vessel, plastic, 9 l, rectangular	0020004382	EUR 350,00
IB 9 pro	Bath vessel, stainless steel, 9 l	0004248500	EUR 470,00

Bath size M

IB 12 pro	Bath vessel, stainless steel, 12 l	0004577500	EUR 530,00
-----------	------------------------------------	------------	------------

Bath size L

IB 18 eco	Bath vessel, plastic, 18 l	0004248200	EUR 460,00
IB HF 24 eco	Bath vessel, plastic, 24 l	0020006884	EUR 520,00
IB R 20 eco	Bath vessel, 20 l, plastic, rectangular	0020004383	EUR 460,00
IB R 52 eco	Bath vessel, 52 l, plastic, rectangular	0020007044	EUR 650,00
IB R RO 15 eco	Bath vessel for magn. stirrer RO 15	0020006341	EUR 790,00
IB R RO 15 pro	Bath vessel for magn. stirrer RO 15	0025007761	EUR 1.190,00
IB 20 pro	Bath vessel, stainless steel, 20 l	0004248600	EUR 630,00



HF.Si.20.200.50



LT 5.20



H.SI.8



ISO.8



ISO.12

Product	Description	Ident. No.	Price
THERMOFLUIDS			
HF.Si.20.250.50A	Heating fluid Si250A; 10 kg	0020003521	EUR 480,00
HF.Si.20.200.50	Heating fluid Si200; 10 kg	0020003520	EUR 430,00
UF.Si.N30.150.10LV	Universal fluid Si150 LV; 9 kg	0020003518	EUR 450,00

HOSES

LT 5.20	High temperature hose kit insulated, 2 x 1,5 m, stainless steel	0002606700	EUR 999,00
LT 5.21	High temperature hose kit insulated, 2 x 1,5 m, PTFE	0020000988	EUR 849,00
H.PVC.8	Hose, PVC, Ø 8 mm, 2 x 1,5 m	0004568800	EUR 12,00
H.PVC.12	Hose, PVC, Ø 12 mm, 2 x 1,5 m	0004568900	EUR 15,00
H.SI.8	Hose, silicone, Ø 8 mm, 2 x 1,5 m	0004569000	EUR 30,00
H.SI.12	Hose, silicone, Ø 12 mm, 2 x 1,5 m	0004569100	EUR 36,00
H.PUR.8.R	Tube PUR 90 °C, Ø 8, 2 x 1,5 m, reinforced	0020004612	EUR 55,00
H.PUR.12	Tube PUR 90 °C, Ø 12, 2 x 1,5 m	0020004613	EUR 68,00
H.FKM.8	Tube FKM, Ø 8 mm, -30 – 180 °C, 2 x 1,5 m	0004569200	EUR 280,00
H.FKM.12	Tube FKM, Ø 12 mm, -30 – 180 °C, 2 x 1,5 m, M 16 x 1	0004569300	EUR 370,00

INSULATION FOR HOSES

ISO.8	Insulation, Ø 8 mm, 2 x 1,5 m	0004569400	EUR 25,00
ISO.12	Insulation, Ø 12 mm, 2 x 1,5 m	0004569500	EUR 32,00



Tube rack, 13 mm, S, stainless



Variable rack, ICC, ML, stainless



Variable bottom, ICC, L, stainless



Bottom plate L



Floating tube rack 1



Floating globes, PP



WH10

Product	Description	Ident. No.	Price
TUBE RACKS			
Tube rack, 13 mm, S, stainless	Stainless steel rack for bath size S, Ø 13 mm	0020004026	EUR 80,00
Tube rack, 17 mm, S, stainless	Stainless steel rack for bath size S, Ø 17 mm	0020004027	EUR 80,00
Tube rack, 22 mm, S, stainless	Stainless steel rack for bath size S, Ø 22 mm	0020004028	EUR 80,00
Tube rack, 13 mm, ML, stainless	Stainless steel rack for bath size M+L, Ø 13 mm	0020004029	EUR 135,00
Tube rack, 17 mm, ML, stainless	Stainless steel rack for bath size M+L, Ø 17 mm	0020004030	EUR 135,00
Tube rack, 22 mm, ML, stainless	Stainless steel rack for bath size M+L, Ø 22 mm	0020004031	EUR 135,00
Variable rack, ICC, ML, stainless	Variable rack for bath size M+L.ICC	0020004032	EUR 175,00
Inlay 1, variable rack, ICC, ML	Inlay for variable rack, Ø 13 mm, 2 pcs.	0020004033	EUR 55,00
Inlay 2, variable rack, ICC, ML	Inlay for variable rack, Ø 17 mm, 2 pcs.	0020004034	EUR 55,00
Inlay 3, variable rack, ICC, ML	Inlay for variable rack, Ø 22 mm, 2 pcs.	0020004035	EUR 55,00
Variable bottom, ICC, L, stainless	Variable bottom for bath size L.ICC	0020004614	EUR 385,00
Bottom plate L	Bottom plate for bath size L	0020006212	EUR 420,00
Bottom plate L, ICC	Bottom plate for bath size L.ICC	0020007353	EUR 350,00
FLOATING RACKS			
Floating tube rack 1	Floating tube rack for 24 x 1,5 / 2,0 ml tubes, 5 pcs.	0020003667	EUR 31,00
Floating tube rack 2	Floating tube rack for 8 x 15 ml tubes, 5 pcs.	0020003668	EUR 31,00
Floating tube rack 3	Floating tube rack for 4 x 50 ml tubes, 5 pcs.	0020003669	EUR 31,00
ADDITIONAL ACCESSORIES			
WH10	WiCo Holder	0020000984	EUR 20,00
PT 100.30	Temp. sensor, stn. steel	0004284700	EUR 285,00
PT 100 extension (Lemo)	Extension cable PT 100, lemo connector, 3 m	0020004629	EUR 175,00
Floating globes, PP	Floating globes, PP, 500 pcs.	0020003666	EUR 105,00
Distribution Pipe	4-sided distributor tube for improved flow in large tanks, stainless steel	0025007781	EUR 115,00



CO V 1



Ball valve M16x1



Mechanic fluid level controller



Elbow tube 90°



Olive for DN 6 hoses



Adapter NTP 1/4



Adapter NTP 3/4

Product	Description	Ident. No.	Price
VALVES AND LEVEL CONTROLLERS			
MV 1	Magnetic valve for cooling water control, max. 100 °C	0020003763	EUR 380,00
CO V 1	Closed pressure valve for external pump connection set, max. 180 °C	0020000249	EUR 560,00
Ball valve M16 x 1	Ball valve, completely opening (M 16 x 1)	0020004620	EUR 80,00
Mechanic fluid level controller	Mechanic fluid level controller	0020004618	EUR 310,00
ADAPTERS			
Elbow tube 90°	Elbow tube 90°	0025001212	EUR 74,00
Elbow Olive 90° for pump	90° tube adapter for pump mounting	0025007462	EUR 50,00
Olive for DN 6 hoses	Olive for DN 6 hoses, 2 pcs.	0020004667	EUR 26,00
Olive for DN 8 hoses	Olive for DN 8 hoses, 2 pcs.	0020004566	EUR 26,00
Olive for DN 10 hoses	Olive for DN 10 hoses, 2 pcs.	0020004568	EUR 26,00
Olive for DN 12 hoses	Olive for DN 12 hoses, 2 pcs.	0020004889	EUR 26,00
Adapter NTP 1/4	Adapter M 16 to NPT 1/4, 2 pcs.	0020004569	EUR 40,00
Adapter NTP 1/2	Adapter M 16 to NPT 1/2, 2 pcs.	0020004570	EUR 125,00
Adapter NTP 3/4	Adapter M 16 to NPT 3/4, 2 pcs.	0020004571	EUR 150,00
Adapter M16x1 f - G 1/4 m	Adapter M 16 x 1 female to G 1/4 male	0020008807	EUR 90,00
Adapter M16x1 m - G 1/4 m	Adapter M 16 x 1 male to G 1/4 male	0020008734	EUR 45,00
Adapter M16x1 m - G 1/2 m	Adapter M 16 x 1 male to G 1/2 male	0020008796	EUR 45,00
Adapter M16x1 f - G 1/2 m	Adapter M 16 x 1 female to G 1/2 male	0020008800	EUR 90,00
Adapter M16x1 f - G 3/8 m	Adapter M 16 x 1 female to G 3/8 male	0020008730	EUR 90,00
Adapter M16x1 m - G 3/8 m	Adapter M 16 x 1 male to G 3/8 male	0020008754	EUR 45,00
Adapter M16x1 m - M16x1 m	Adapter M 16 x 1 male to M 16 x 1 male, for hose extension	0025007118	EUR 45,00
Lock nut	Lock nut, 2 pcs.	0020004583	EUR 30,00
Stopper	Stopper, 2 pcs.	0020004584	EUR 30,00

IKA has a diverse range of dry block heaters designed to accommodate various interchangeable heating blocks. They provide precise temperature control for reproducible results. These digital block heaters are ideal for melting and boiling point determination, enzyme reactions, incubation and activation of cultures, immunoassays, DNA denaturation, culture media tests, coagulation tests, blood urea nitrogen determinations and in situ hybridizations.

DRY BLOCK HEATERS

/// Provide precise temperature control in small vessels



Digital block heaters for up to four aluminum blocks provide precise temperature control in small vessels. Included PT 1000 temperature sensor allows temperature control directly in the sample vessel. It is used with PCR tubes, PCR strips, Greiner tubes, microplates and cuvettes. The digital dry block heaters with precisely designed blocks ensure highly accurate and reproducible results, guaranteeing short heating times. The bright, easy to read LED display facilitates very easy setting of the required temperature and accurate monitoring of the actual temperature. Excellent temperature uniformity and stability is ensured.

TIMER
Countdown, adjustable from 1 min to 99 h 59 min.

FIXED SAFETY CIRCUIT

ACCESSORIES
Highly versatile with a large number of blocks.

Dry Block Heater 1

EUR 978,00
Ident. No. 0004025100



Dry Block Heater 2

EUR 1.184,00
Ident. No. 0004025200



Dry Block Heater 3

EUR 1.390,00
Ident. No. 0004025300

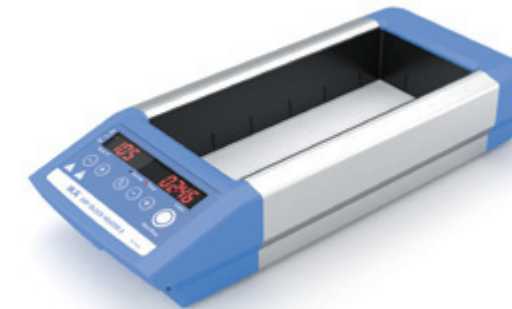

Dry Block Heater 4

EUR 1.596,00
Ident. No. 0004025400

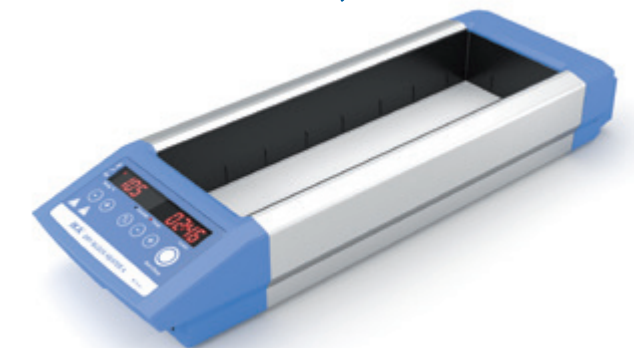

TECHNICAL DATA	DRY BLOCK HEATER 1	DRY BLOCK HEATER 2	DRY BLOCK HEATER 3	DRY BLOCK HEATER 4
Number of blocks	1	2	3	4
Heat output	165 W	250 W	330 W	412 W
Heating temperature range	RT +5 °C – 120 °C	RT +5 °C – 120 °C	RT +5 °C – 120 °C	RT +5 °C – 120 °C
Connection for ext. temperature sensor	CT (DIN 12878)	CT (DIN 12878)	CT (DIN 12878)	CT (DIN 12878)
Temperature homogeneity at 37 / 60 °C	0,2 K / 0,4 K	0,2 K / 0,4 K	0,3 K / 0,6 K	0,3 K / 0,6 K
Set-up plate dimensions	96 × 76 mm	96 × 152 mm	96 × 228 mm	96 × 304 mm
Dimensions (W × H × D)	151 × 73 × 228 mm	151 × 73 × 304 mm	151 × 73 × 380 mm	151 × 73 × 456 mm
Protection class according to DIN EN 60529	IP 21	IP 21	IP 21	IP 21



DB 1.1

Product	Description	Ident. No.	Price
U MICRO CENTRIFUGE TUBES			
DB 1.1	Single block, PCR tubes, Ø 7,9 mm	0004467600	EUR 101,00
DB 1.2	Single block, Eppendorf tubes, Ø 11,5 mm	0004467700	EUR 101,00
DB 1.3	Single block, microtubes, Ø 11,1 mm	0004467800	EUR 101,00
DB 1.4	Single block, VWR Eppendorf tubes, Ø 11,5 mm	0004467900	EUR 101,00
DB 1.5	Single block, corning tubes, Ø 10,9 mm	0004468000	EUR 101,00

Product	Description	Ident. No.	Price
U CONICAL BOTTOM CENTRIFUGE TUBES			
DB 2.1	Single block, conical tubes, Ø 17,1 mm	0004468100	EUR 101,00
DB 2.2	Single block, conical tubes, Ø 29 mm	0004468200	EUR 101,00

Product	Description	Ident. No.	Price
U COMBINATION BLOCKS			
DB 3.1	Single block, test tube comb., 6 12 13 25 mm	0004468300	EUR 101,00
DB 3.2	Single block, centrifuge comb., 1,5 15 50 ml	0004468400	EUR 101,00
DB 3.3	Single block, microtube comb., 0,5 1,5 2 ml	0004468500	EUR 101,00



DB 3.2

Product	Description	Ident. No.	Price
U STANDARD TEST TUBES			
DB 4.1	Single block, 30 round tubes, Ø 8,3 mm	0004468600	EUR 108,00
DB 4.2	Single block, 24 round tubes, Ø 10,7 mm	0004468700	EUR 108,00
DB 4.3	Single block, 16 round tubes, Ø 13,9 mm	0004468800	EUR 108,00
DB 4.4	Single block, 20 round tubes, Ø 13,9 mm	0004468900	EUR 108,00
DB 4.5	Single block, 12 round tubes, Ø 17,5 mm	0004469000	EUR 108,00
DB 4.6	Single block, 8 round tubes, Ø 21 mm	0004469100	EUR 108,00
DB 4.7	Single block, 6 round tubes, Ø 26,2 mm	0004469200	EUR 108,00
DB 4.8	Single block, 4 round tubes, Ø 35 mm	0004469300	EUR 108,00
DB 4.9	Single block, 12 round tubes, Ø 19,1 mm	0004469400	EUR 108,00



DB 4.6



DB 5.1

Product	Description	Ident. No.	Price
U VIALS			
DB 5.1	Single block, 12 mm vials, Ø 12,7 mm	0004469500	EUR 108,00
DB 5.2	Single block, 15 mm vials, Ø 15,8 mm	0004469600	EUR 108,00
DB 5.3	Single block, 17 mm vials, Ø 17,8 mm	0004469700	EUR 108,00
DB 5.4	Single block, 19 mm vials, Ø 19,7 mm	0004469800	EUR 108,00
DB 5.5	Single block, 21 mm vials, Ø 21,7 mm	0004469900	EUR 108,00
DB 5.6	Single block, 23 mm vials, Ø 23,8 mm	0004470000	EUR 108,00
DB 5.7	Single block, 25 mm vials, Ø 25,8 mm	0004470100	EUR 108,00
DB 5.8	Single block, 28 mm vials, Ø 28,8 mm	0004470200	EUR 108,00
DB 5.9	Single block, 16 mm vials, Ø 16,4 mm	0004470300	EUR 108,00

Product	Description	Ident. No.	Price
U STANDARD TEST TUBES			
DB 6.1	Single block, 10 x 8 PCR tube strips, Ø 6,4 mm	0004470400	EUR 101,00
DB 6.2	Single block, 64 PCR tubes, Ø 6,4 mm	0004470500	EUR 101,00
DB 6.3	Double block, 1 x 96-Well PCR plate, Ø 6,4 mm	0004470600	EUR 249,00
DB 7.1	Double block, 96- or 384-Well-plate	0004470800	EUR 149,00
DB 8.1	Single block, 2 x 6 cuvettes, Ø 12,5 mm	0004470700	EUR 101,00



DB 6.3

Product	Description	Ident. No.	Price
TEMPERATURE SENSORS			
PT 1000.60	Temp. sensor, stn. steel	0003516800	EUR 120,00
PT 1000.90	Temp. sensor, coated	0004480600	EUR 169,00



DB 8.1

IKA heating baths are developed with a strong focus on safety. All baths are equipped with a double jacket to protect against burns and a safety temperature monitor prevents overheating of the bath. After turning on the unit, the safety functions are automatically checked.

HB DIGITAL

/// Enlarged volume

The new universal heating bath HB digital now has a volume of 4 liters and is especially designed to work with our rotary evaporators. Apart from that, the unit can be operated as a stand-alone device for applications within preparative chemistry. It is easily operated by a push-button and a key switch locks temperature settings to prevent unintentional adjustments. Due to its ergonomic handles the device can be moved effortlessly within the laboratory. Its safety circuit is adjustable.

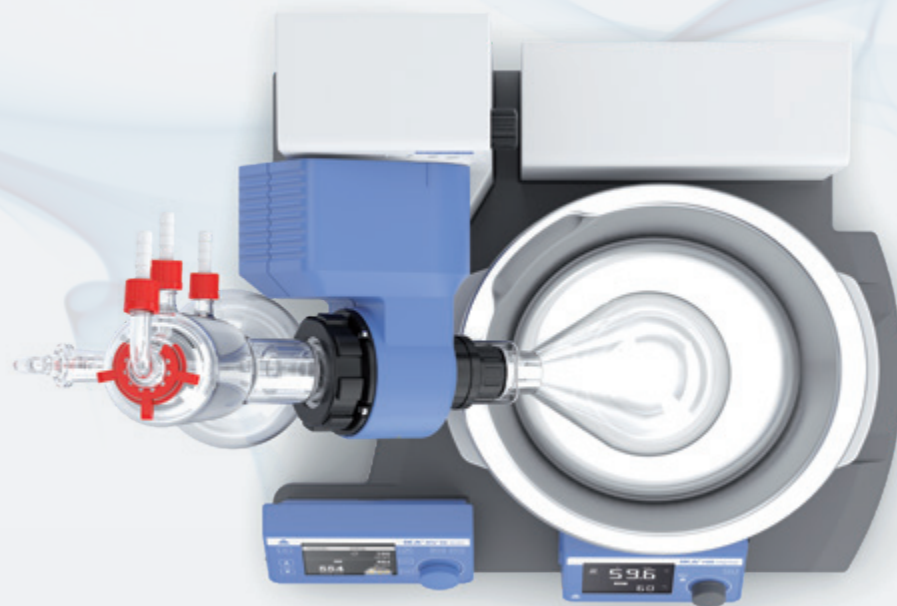

HB eco

EUR 1.050,00
Ident. No. 0020016337



HB digital

EUR 1.309,00
Ident. No. 0020016334



Heating temperature up to 180 °C

HBR 4 control

EUR 3.527,00
Ident. No. 0020003549

Integrated magnetic stirrer drive



Product	Ident. No.	Price
ACCESSORIES HB ECO DIGITAL		
HB 10.3 Protection cover HB eco and digital	0020024125	EUR 755,00
ACCESSORIES HBR 4 CONTROL		
H 240 Ring set	0002858700	EUR 494,00
H 159 Intermediate bottom	0001809700	EUR 226,00

TECHNICAL DATA	HB ECO DIGITAL	HBR 4 CONTROL
Heating temperature max.	99 °C 180 °C	200 °C
Filling volume max.	4 l	4 l
Filling point min.	60 mm	20 mm
Heat output	1400 W 1350 W	1000 W
Safety circuit	109 °C 50 – 190 °C	50 – 210 °C
Heat control	Turning knob LCD	LCD
Inner diameter	225 mm	200 mm
Dimensions (W x H x D)	330 x 190 x 325 mm	340 x 250 x 340 mm
Protection class according to DIN EN 60529	IP 21	IP 20



H 240



H 159

The IKA Oven 125 are universal drying ovens for tempering, drying, aging and heating tasks in the laboratory. Rapid heating and exact temperature regulation guarantee reproducible results in industrial laboratories, schools and universities, research, quality control or science.

OVEN 125 CONTROL - DRY

/// The largest drying chamber in its class

IKA Oven 125 control - dry is a forced convection heating and drying chamber and heats up to 300 °C. The additional temperature selection limited TWB (DIN 12880) meets the highest security requirements. Furthermore, the temperature curve can be monitored during testing independently of the safety temperature. This means that the test material is always protected.

A WELL THOUGHT OUT INTERIOR

The generously dimensioned interior of the Oven 125 control - dry is comfortably illuminated. A practical cable bushing at the rear of the device is provided as standard for measurements in the oven or in the test material. The fan switches off automatically if the door is opened. Up to 6 insertable shelves can be accommodated in the interior made of stainless steel.

INTERFACES

The Oven 125 control - dry offers an interface for an additional sensor for direct temperature regulation in the test material. Test parameters can be stored directly on a USB stick.



TWO DISPLAYS

All important process parameters are displayed clearly on two large TFT displays. The temperature profiles and individual user profiles can be entered via the intuitive user interface. The real-time clock enables convenient digital documentation and a time-delayed start.

Oven 125 basic - dry

EUR 1.999,00

Ident. No. 0020003215

Oven 125 basic - dry glass

EUR 2.330,00

Ident. No. 0020003956



Oven 125 control - dry

EUR 2.999,00

Ident. No. 0020003990

Oven 125 control - dry glass

EUR 3.399,00

Ident. No. 0020003996



Product	Ident. No.	Price
ACCESSORIES		
IO T 1.00 wire grid tray, chrome plated	0020024935	EUR 120,00
IO T 1.10 enhanced wire grid tray	0020007600	EUR 210,00
IO F 1.10 roller frame	0020007601	EUR 750,00
IO B 1.10 roller box	0020007602	EUR 860,00
IO P 1.10 table top work plate	0020007603	EUR 800,00
IO F 1.20 spacer frame	0035001326	EUR 430,00
PT 100.31 temp. sensor	0020009564	EUR 276,00

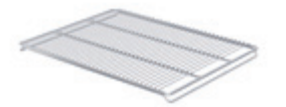

IO T 1.10



IO B 1.10



IO F 1.20

TECHNICAL DATA	OVEN 125 BASIC (DRY DRY GLASS)	OVEN 125 CONTROL (DRY DRY GLASS)
Principle of heat transfer	Natural convection	Forced convection (fan adjustable in 10 steps)
Total volume inner chamber	125 l	125 l
Working temperature	RT +5 °C – 250 °C	RT +5 °C – 300 °C
Heat output	2400 W	2400 W
Temperature constancy in medium	± 0,3 K	± 0,3 K
Temperature Safety Class (DIN 12880)	TB (Class 1)	TB (Class 1); TWB (Class 2)
Cable access port	No	Yes
Interior lighting	No	Yes
PT 100 interface	No	Yes
Protection class according to DIN EN 60529	IP 20	IP 20
Dimensions (W × H × D)	700 × 825 × 650 mm	700 × 825 × 650 mm

IKA rotary evaporators set new standards for safety, efficiency and ease of use. These products offer excellent distilling solutions. All IKA RV 10 evaporators are equipped with an automated lift including a safety stop function. More safety features are: interval operation, smooth start, end position recognition, automated lift-out in case of power outage as well as a timer function.

RV 10 AUTO PRO

/// The flagship



RV 10 auto pros' features include an innovative handling concept with a bright, high-contrast TFT color display, an integrated vacuum controller, cooling water monitoring and mature safety standards.

EFFICIENT AND COST-EFFECTIVE OPERATIONS
These include automatic control of the vacuum and cooling water volume.

INNOVATIVE FEATURES

Smooth start, interval mode, right-left operation in interval mode, and the timer function for time-lapse tests make everyday work in the laboratory much easier.

SAFETY FEATURES

Safety is ensured by the motorized lift with safety stop function. Additional safety for users is provided by e.g. individually adjustable temperature safety circuits, protection against boiling dry and adjustable end-point recognition to prevent glass breakage.

① RV 3 V

EUR 2.181,00

Ident. No. 0010003324

② RV 3 V-C

EUR 2.326,00

Ident. No. 0010003328

③ RV 3 FLEX

EUR 2.045,00

Ident. No. 0010003331

① RV 8 V

EUR 2.717,00

Ident. No. 0010003482

② RV 8 V-C

EUR 2.869,00

Ident. No. 0010003485

③ RV 8 FLEX

EUR 2.571,00

Ident. No. 0010003488



TECHNICAL DATA	RV 3	RV 8
Motor type	Brushless DC drive motor	Brushless DC drive motor
Speed range	20 – 300 rpm	5 – 300 rpm
Speed display	Scale	Digital
Heating temperature range	RT – 99 °C	RT – 180 °C
Type of cooling	Vertical	Vertical
Cooling surface	1500 cm ²	1500 cm ²
Soft start	Yes	Yes
Head angle adjustable	0 to 60 °	0 to 45 °
Stroke displacement	150 mm, manual	120 mm, manual
Vacuum controller	Optional	Optional
Dimensions (W × H × D) without glass parts	440 × 530 × 330 mm	510 × 490 × 345 mm
Protection class acc. to DIN EN 60529	IP 20	IP 20

- ① **RV 10 digital V**
EUR 4.098,00
Ident. No. 0010004799
- ② **RV 10 digital V-C**
EUR 4.441,00
Ident. No. 0010004802
- ③ **RV 10 digital FLEX**
EUR 3.071,00
Ident. No. 0010004805



TECHNICAL DATA	RV 10 DIGITAL
Motor type	Brushless DC drive motor
Speed range	5 – 280 rpm
Speed display	Digital
Clockwise and counter-clockwise	Yes
Heating temperature range	RT – 180 °C
Type of cooling	Vertical
Cooling surface	1500 cm ²
Filling volume max.	4 l
Soft start	Yes
Head angle adjustable	0 to 45°
Stroke displacement	140 mm, motorized
Setting of lower end stop	60 mm, contact free
Vacuum controller	Optional
Dimensions (W × H × D) without glass parts	500 × 430 × 440 mm
Protection class acc. to DIN EN 60529	IP 20



- ① **RV 10 auto V**
EUR 6.798,00
Ident. No. 0010004835
- ② **RV 10 auto V-C**
EUR 7.212,00
Ident. No. 0010004838
- ③ **RV 10 auto FLEX**
EUR 5.730,00
Ident. No. 0010004841
- ④ **RV 10 auto pro V**
EUR 8.627,00
Ident. No. 0010004815*
- ⑤ **RV 10 auto pro V-C**
EUR 9.026,00
Ident. No. 0010004812*
- ⑥ **RV 10 auto pro FLEX**
EUR 8.277,00
Ident. No. 0010004818*



TECHNICAL DATA	RV 10 AUTO
Motor type	Brushless DC drive motor
Speed range	5 – 300 rpm
Speed display	Digital
Clockwise and counter-clockwise	Yes
Heating temperature range	RT – 180 °C
Type of cooling	Vertical condenser
Cooling surface	1500 cm ²
Filling volume max.	4 l
Soft start	Yes
Head angle adjustable	0 to 45°
Stroke displacement	140 mm, motorized
Setting of lower end stop	60 mm, contact free
Vacuum controller	Integrated
Dimensions (W × H × D) without glass parts	500 × 430 × 440 mm
Protection class acc. to DIN EN 60529	IP 20

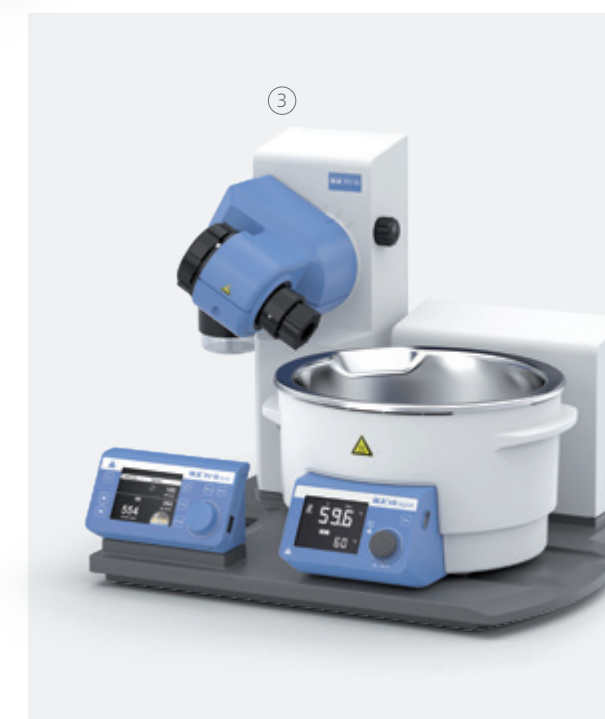

*Pro packages include VACSTAR digital



RV 10.1

RV 10.1 enlarged surface



RV 10.3

RV 10.4



RV 10.400

RV 10.500



RV 10.600

RV 10.606



RV 10.84

RV 10.301

Product	Description	Ident. No.	Price
ACCESSORIES RV 10, RV 8, RV 3			
RV 10.1	Set of glassware, vertical	0003655300	EUR 800,00
RV 10.10	Set of glassware, vertical, coated	0003755400	EUR 1.124,00
RV 10.1 enlarged surface	Vertical-condenser, enlarged surface	0020019652	EUR 1.192,00
RV 10.10 enlarged surface	Vertical-condenser, coated, enlarged surface	0020019654	EUR 986,00
RV 10.2	Set of glassware, diagonal	0003755300	EUR 826,00
RV 10.20	Set of glassware, diagonal, coated	0003755500	EUR 1.144,00
RV 10.3	Vertical-intensive condenser, manifold	0003741000	EUR 962,00
RV 10.30	Vertical-intensive condenser, manifold, coated	0003741100	EUR 1.317,00
RV 10.4	Dry ice condensor	0003742000	EUR 1.397,00
RV 10.40	Dry ice condensor, coated	0003742100	EUR 1.548,00
RV 10.5	Vertical-condenser, reflux	0003743000	EUR 1.547,00
RV 10.50	Vertical-condenser, reflux, coated	0003743100	EUR 1.696,00
RV 10.6	Vertical-intensive condenser, reflux	0003744000	EUR 1.699,00
RV 10.60	Vertical-intensive condenser, reflux, coated	0003744100	EUR 1.851,00
RV 05.10	Balljoint clamp	0000736600	EUR 17,50
RV 10.88	Clamp, NS 29	0003683300	EUR 17,50
RV 10.400	Evaporation cylinder, NS 29/32, 500 ml	0003738800	EUR 631,00
RV 10.401	Evaporation cylinder, NS 29/32, 1500 ml	0003738900	EUR 721,00
RV 10.500	Foam brake, NS 29/32	0003739200	EUR 133,00
RV 10.600	Distilling spider, NS 29/32, 6 sleeves	0003739400	EUR 540,00
RV 10.601	Distilling spider, NS 29/32, 12 sleeves	0003739500	EUR 904,00
RV 10.602	Distilling spider, NS 29/32, 20 sleeves	0003739600	EUR 1.267,00
RV 10.610	Distilling sleeve, 20 ml	0003919400	EUR 15,40
RV 10.606	Distilling spider with 5 flasks, 50 ml	0003740800	EUR 659,00
RV 10.607	Distilling spider with 5 flasks, 100 ml	0003740900	EUR 722,00
RV 10.90	Evaporation flask, NS 24/29, 50 ml	0003741200	EUR 15,40
RV 10.91	Evaporation flask, NS 24/29, 100 ml	0003741300	EUR 18,50
RV 10.80	Evaporation flask, NS 29/32, 50 ml	0003740100	EUR 30,50
RV 10.800	Evaporation flask, coated, NS 29/32, 50 ml	0020005330	EUR 62,50
RV 10.81	Evaporation flask, NS 29/32, 100 ml	0003740200	EUR 30,50
RV 10.810	Evaporation flask, coated, NS 29/32, 100 ml	0020005331	EUR 62,50
RV 10.82	Evaporation flask, NS 29/32, 250 ml	0003740300	EUR 58,50
RV 10.820	Evaporation flask, coated, NS 29/32, 250 ml	0020005332	EUR 118,00
RV 10.83	Evaporation flask, NS 29/32, 500 ml	0003740400	EUR 61,50
RV 10.830	Evaporation flask, coated, NS 29/32, 500 ml	0020005333	EUR 123,00
RV 10.84	Evaporation flask, NS 29/32, 1000 ml	0003740500	EUR 62,50
RV 10.840	Evaporation flask, coated, NS 29/32, 1000 ml	0004221400	EUR 127,00
RV 10.85	Evaporation flask, NS 29/32, 2000 ml	0003740600	EUR 99,50
RV 10.850	Evaporation flask, coated, NS 29/32, 2000 ml	0020005334	EUR 199,00
RV 10.86	Evaporation flask, NS 29/32, 3000 ml	0003740700	EUR 153,00
RV 10.860	Evaporation flask, coated, NS 29/32, 3000 ml	0020005335	EUR 306,00

Product	Description	Ident. No.	Price
ACCESSORIES RV 3, RV 8, RV 10			
RV 10.100	Receiving flask, KS 35/20, 100 ml	0003742200	EUR 54,50
RV 10.101	Receiving flask, KS 35/20, 250 ml	0003742300	EUR 55,50
RV 10.102	Receiving flask, KS 35/20, 500 ml	0003742400	EUR 59,50
RV 10.103	Receiving flask, KS 35/20, 1000 ml	0003742500	EUR 62,50
RV 10.104	Receiving flask, KS 35/20, 2000 ml	0003742600	EUR 103,00
RV 10.105	Receiving flask, KS 35/20, 3000 ml	0003742700	EUR 193,00
RV 10.200	Receiving flask, coated, KS 35/20, 100 ml	0003743200	EUR 108,00
RV 10.201	Receiving flask, coated, KS 35/20, 250 ml	0003743300	EUR 112,00
RV 10.202	Receiving flask, coated, KS 35/20, 500 ml	0003743400	EUR 138,00
RV 10.203	Receiving flask, coated, KS 35/20, 1000 ml	0003743500	EUR 164,00
RV 10.204	Receiving flask, coated, KS 35/20, 2000 ml	0003743600	EUR 184,00
RV 10.205	Receiving flask, coated, KS 35/20, 3000 ml	0003743700	EUR 245,00
RV 10.300	Powder flask, NS 29/32, 500 ml	0003738200	EUR 145,00
RV 10.301	Powder flask, NS 29/32, 1000 ml	0003738300	EUR 155,00
RV 10.302	Powder flask, NS 29/32, 2000 ml	0003738400	EUR 192,00
RV 10.70	Vapor tube, NS 29/32	0003812200	EUR 97,50
RV 10.74	Vapor tube, short, NS 29/32	0003971700	EUR 84,00
RV 10.8001	Seal, PTFE, stn. steel	0003907000	EUR 105,00
RV 10.3000	Extension plate	0003859000	EUR 133,00



RV 10.103



RV 10.74



RV 10.8001

RV 10.3000

ACCESSORIES RV 3

RV 3.1	Support pole	0025004587	EUR 97,50
RV 3.4	Woulff bottle	0025004588	EUR 135,00
RV 10.5005	Hose kit	0020000552	EUR 97,50

ACCESSORIES RV 8

RV 8.1	Support pole	0004438500	EUR 97,50
RV 8.2	Mechanical end stop for RV 8	0025001342	EUR 50,00
RV 8.3	Stand pole	0025004707	EUR 109,00
RV 10.5005	Hose kit	0020000552	EUR 97,50

ACCESSORIES VALVE RV 10 AUTO

RV 10.4002	Magnetic valve laboratory vacuum	0003880300	EUR 636,00
RV 10.5001	Choke water valve	0003902700	EUR 506,00
RV 10.5002	Filter	0003903800	EUR 62,50
RV 10.5003	Pressure regulating valve	0003907100	EUR 200,00



RV 3.1

RV 3.4



RV 10.4002



RV 10.5003

The IKA centrifuges are ideal for applications which do not require ultra high speeds, e.g. micro-filtrations and cell separations. The centrifuges mini G and G-L feature a compact design and a small footprint. As a safety feature, the IKA centrifuges will only operate when the lid is closed.

The clearest display
in its class

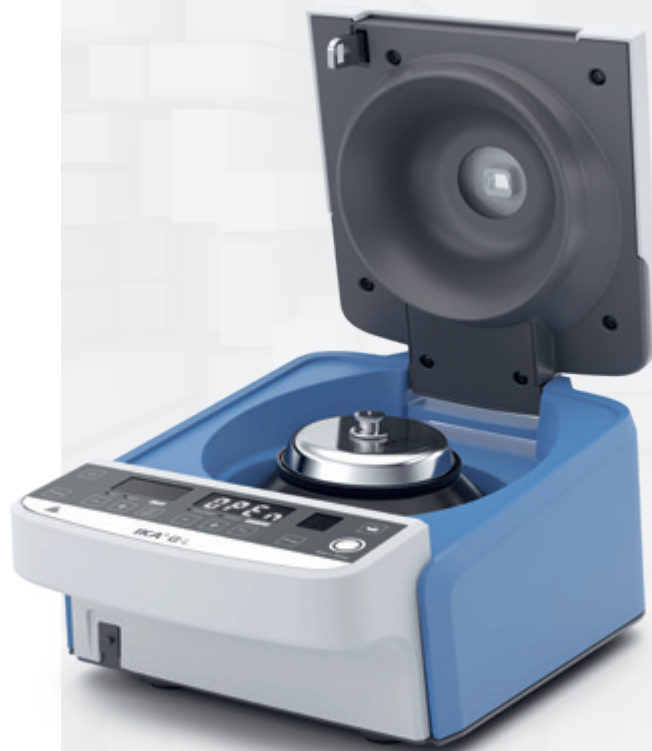

IKA G-L

/// The universal midi centrifuge

Separating substances at medium rotational speeds: IKA G-L is the ideal midi centrifuge for all types of separation processes such as those found in molecular biology. It can be used with standard 1,5 / 2 ml vessels, as well as with PCR strips. The cover opens automatically at the press of a button.

SAFE USE

The centrifuge is fitted with a metal cover and does not start until it is firmly closed.

STATE-OF-THE-ART DISPLAY

The completely intuitive navigation is carried out through a membrane keypad. This allows an easy setting of speed, rotational speed or programmes.

POWERFUL MOTOR

With a rotational speed of up to 15 700 rpm, the centrifuge is fitted with a high-performance motor.

IKA mini G

EUR 313,00

Ident. No. 0003958000*



*Adapters included in delivery

IKA G-L

EUR 999,00

Ident. No. 0030000774



Product	Ident. No.	Price
ACCESSORIES IKA G-L		
Rotor 4 x HPLC	0020022341	EUR 40,00
IKA G-L, PCR Set	0030001345	EUR 199,00
IKA G-L, Adapter PCR tube	0030001346	EUR 9,00
IKA G-L, Adapter 0,5 ml tube	0030001347	EUR 9,00
IKA G-L, Adapter 0,4 ml tube	0030001334	EUR 9,00
IKA G-L, 2 ml rotor set	0030001333	EUR 250,00



IKA G-L, PCR Set

TECHNICAL DATA	IKA MINI G	IKA G-L
Capacity	8 × 2,0 ml	12 × 1,5 / 2,0 ml
Centrifugal acceleration	2000 G	16 500 G
Speed range	6000 rpm	800 – 15 700 rpm
Motor rating input	12 W	65 W
Speed deviation	5 %	5 %
Quick stop	Yes	Yes
Cover opening	Automatic	Automatic
Protective cover	Yes	Yes
Dimensions (W × H × D)	155 × 105 × 175 mm	200 × 140 × 280 mm
Weight	1,4 kg	3,9 kg

An ergonomic feel combined with uncompromising precise performance: the IKA single fix and vario pipettes can be used for many applications in the modern laboratory. Colour coding simplifies the rapid selection of a suitable pipette. Resistance to impact, UV and chemicals ensures that the tip cone provides long-term reliable dosing. The IKA PETTE fix and vario are fully autoclavable, therefore ensuring easy sterilization. This guarantees fault-free, precise and safe operation.

IKA PETTE fix

/// Simple liquid handling for fixed volumes

ERGONOMIC DESIGN

IKA pipettes are delivered including exchangeable grips in different shapes and materials. The minimal frictional and spring forces also ensure dosing with ergonomic handling; without any effort.



DURABLE CONSTRUCTION

The tip cone and piston are coated with a high quality diamond-like carbon (DLC).

SIMPLE MAINTENANCE AND ADJUSTMENT

The volume unit with piston and seal can be disassembled and cleaned in just a few simple steps. If adjustment is necessary, it can be done without any additional tool.



- ① **IKA PETTE fix 5 µl**
EUR 144,00
Ident. No. 0020011219
- ② **IKA PETTE fix 10 µl**
EUR 144,00
Ident. No. 0020011220
- ③ **IKA PETTE fix 20 µl**
EUR 144,00
Ident. No. 0020011221
- ④ **IKA PETTE fix 25 µl**
EUR 144,00
Ident. No. 0020011222
- ⑤ **IKA PETTE fix 50 µl**
EUR 144,00
Ident. No. 0020011223
- ⑥ **IKA PETTE fix 100 µl**
EUR 144,00
Ident. No. 0020011224
- ⑦ **IKA PETTE fix 200 µl**
EUR 144,00
Ident. No. 0020011225
- ⑧ **IKA PETTE fix 250 µl**
EUR 144,00
Ident. No. 0020011226
- ⑨ **IKA PETTE fix 500 µl**
EUR 144,00
Ident. No. 0020011227
- ⑩ **IKA PETTE fix 1000 µl**
EUR 144,00
Ident. No. 0020011228



	IKA PETTE FIX	MAX. VOLUME TIP
①	5 µl	10 µl
②	10 µl	10 µl
③	20 µl	200 µl
④	25 µl	200 µl
⑤	50 µl	200 µl

	IKA PETTE FIX	MAX. VOLUME TIP
⑥	100 µl	200 µl
⑦	200 µl	200 µl
⑧	250 µl	1000 µl
⑨	500 µl	1000 µl
⑩	1000 µl	1000 µl

① IKA PETTE vario 0,1 – 2 µl

EUR 219,00
Ident. No. 0020011210

② IKA PETTE vario 0,5 – 10 µl

EUR 219,00
Ident. No. 0020011211

③ IKA PETTE vario 2 – 20 µl

EUR 219,00
Ident. No. 0020011213

④ IKA PETTE vario 10 – 100 µl

EUR 219,00
Ident. No. 0020011214

⑤ IKA PETTE vario 20 – 200 µl

EUR 219,00
Ident. No. 0020011215

⑥ IKA PETTE vario 100 – 1000 µl

EUR 219,00
Ident. No. 0020011216

⑦ IKA PETTE vario 0,5 – 5 ml

EUR 219,00
Ident. No. 0020011217

⑧ IKA PETTE vario 1 – 10 ml

EUR 219,00
Ident. No. 0020011218



IKA PETTE VARIO MAX. VOLUME TIP

①	0,1 – 2 µl	10 µl
②	0,5 – 10 µl	10 µl
③	2 – 20 µl	200 µl
④	10 – 100 µl	200 µl

IKA PETTE VARIO MAX. VOLUME TIP

⑤	20 – 200 µl	200 µl
⑥	100 – 1000 µl	1000 µl
⑦	0,5 – 5 ml	5 ml
⑧	1 – 10 ml	10 ml



LINEA



Pipette tips

Product	Description	Ident. No.	Price
ACCESSORIES			
LINEA	Pipette rack	0020018987	EUR 69,00
Tip xs bag	Pipette tip, 10 µl, transparent, 10 000 pcs.	0020017816	EUR 359,00
Tip xs tray	Pipette tip, 10 µl, transparent, 2304 pcs.	0020017818	EUR 110,00
Tip xs box +	Filter tip, 10 µl, sterile, transparent, 1920 pcs.	0020017820	EUR 229,00
Tip s bag	Pipette tip, 200 µl, transparent, 10 000 pcs.	0020017822	EUR 229,00
Tip s tray	Pipette tip, 200 µl, transparent, 1920 pcs.	0020017823	EUR 99,00
Tip s box +	Filter tip, 200 µl, sterile, transparent, 1920 pcs.	0020017824	EUR 229,00
Tip m bag	Pipette tip, 1000 µl, transparent, 5000 pcs.	0020017826	EUR 129,00
Tip m box	Pipette tip, 1000 µl, transparent, 1000 pcs.	0020017827	EUR 60,00
Tip m box +	Filter tip, 1000 µl, sterile, transparent, 1000 pcs.	0020017828	EUR 119,00
Tip l bag	Pipette tip, 5 ml, transparent, 2500 pcs.	0020017829	EUR 300,00
Tip l box	Pipette tip, 5 ml, transparent, 500 pcs.	0020017830	EUR 149,00
Tip xl bag	Pipette tip, 10 ml, transparent, 1000 pcs.	0020017831	EUR 325,00
Tip xl box	Pipette tip, 10 ml, transparent, 250 pcs.	0020017832	EUR 190,00
Pipette tip box xs/s	Stacking box, 6 pcs.	0020017834	EUR 90,00
Refill tray xs	Refill tray, 25 pcs.	0020017836	EUR 125,00
Refill tray s	Refill tray, 25 pcs.	0020017837	EUR 125,00
Pipette tip box m	Stacking box, 10 pcs.	0020017892	EUR 150,00
Filter L	Filter for single-channel pipette 5 ml, 100 pcs.	0020016449	EUR 69,00
Filter XL	Filter for single-channel pipette 10 ml, 100 pcs.	0020016450	EUR 69,00



SOFTWARE
Pipette Calibration Software

EUR 204,00
Ident. No. 0020022141

User-friendly calibration software for planning, performing and recording all calibration tests.

IKA lab reactors are the most unique systems when it comes to optimizing and reproducing chemical reactions, mixing, dispersing and homogenization processes on a lab scale. The lab reactors can be individually customized to perform numerous tasks, including production of creams and lotions, grinding and disintegrating of solids and fibers in liquids or polymers, etc. Single-walled or double-walled vessels made from borosilicate glass or stainless steel are available, each with or without bottom discharge valve.

LR 1000 CONTROL SYSTEM

/// Reactor with weighing function and cooling water control

The LR 1000 control is a cost efficient, modular laboratory reactor designed to optimize chemical reaction processes as well as for mixing, dispersing and homogenization tasks on a lab scale particularly in the cosmetic and pharmaceutical industry. The system can be adapted quickly and easily to a wide range of applications and specific requirements.

Prominent features are its intuitive menu navigation, integrated pH and temperature sensor connection as well as several interfaces that allow display and storage of process-relevant data on a PC. By using the laboratory software labworldsoft® (accessory) it is possible to even control the reactor via PC and make further settings. In addition, a control valve connection to attach a magnetic valve (accessory) for program-based cooling water control is integrated.



LR 1000 basic Package

EUR 5.840,00

Ident. No. 0008040100



With just one base unit multiple vessels can be used!



reddot design award
winner 2013



German
Design Award
SPECIAL
MENTION 2015

LR 1000 control System

EUR 10.391,00

Ident. No. 0025001991

Weighing range:
max. 2 kg

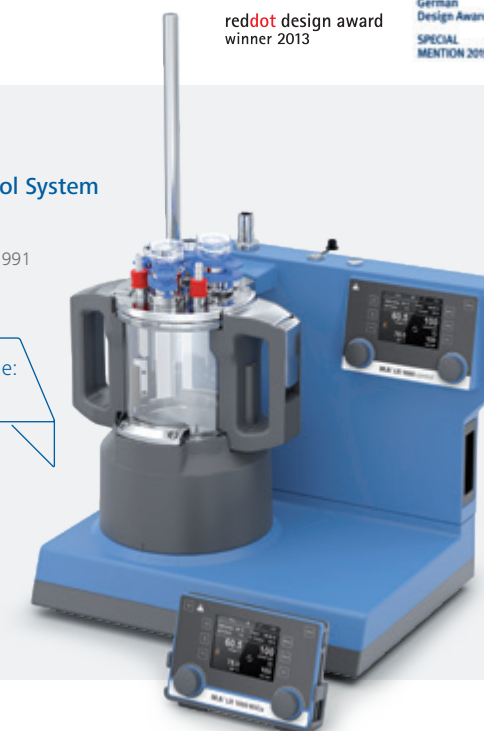

TECHNICAL DATA	LR 1000 BASIC	LR 1000 CONTROL SYSTEM*
Usable volume (with disperser tool)	500 – 1000 ml	500 – 1000 ml
Attainable vacuum	25 mbar	25 mbar
Max. viscosity	100 000 mPas	100 000 mPas
Speed range	10 – 150 rpm	10 – 150 rpm
Display	LED	TFT
Working temperature max.	120 °C	120 °C
Heat control accuracy	± 1 K	± 1 K
Heat output	1000 W	1000 W
Dimensions (W x H x D)	443 x 360 x 295 mm	443 x 360 x 295 mm

* PT 100.30 included in delivery

LR-2.ST
The High-Performer

EUR 11.554,00
Ident. No. 0020013291

LR-2.ST stand system
+ LR-2.SI safety disconnection
+ EUROSTAR 200 control P4
overhead stirrer



LR-2.ST
The Allrounder

EUR 10.513,00
Ident. No. 0020013292

LR-2.ST stand system
+ LR-2.SI safety disconnection
+ EUROSTAR 200 control
overhead stirrer



LR-2.ST
The Versatile

EUR 10.071,00
Ident. No. 0020013293

LR-2.ST stand system
+ LR-2.SI safety disconnection
+ EUROSTAR 100 control
overhead stirrer



LR-2.ST
The Compact Power

EUR 9.538,00
Ident. No. 0020013294

LR-2.ST stand system
+ LR-2.SI safety disconnection
+ EUROSTAR 60 control
overhead stirrer



TECHNICAL DATA	LR-2.ST
Min. volume (anchor stirrer)	500 ml
Min. volume (T 25 digital)	800 ml
Max. volume	2000 ml
Max. working temperature	230 °C
Attainable vacuum	25 mbar
Max. viscosity (EUROSTAR 200 control P4)	150 000 mPas
Speed range (EUROSTAR 200 control P4)	0 4 – 530 rpm
Max. torque at stirring shaft (EUROSTAR 200 control P4)	660 Ncm
Materials in contact with medium	Stainless steel (AISI 316L) FFPM Borosilicate glass 3.3
Height of telescopic stand	620 – 1010 mm
Dimensions (W × H × D)	460 × 1240 × 430 mm

LR-2.ST STARVISC 200
/// Stirs and displays viscosity

The reactor system is particularly helpful during product development, because the measuring stirrer STARVISC 200-2.5 control already clearly indicates while running research programs as to whether the stirred substance can be used as desired. The system is particularly characterized by the agitator mounting, which allows for a safe transfer of the higher motor torque. In combination with STARVISC it is possible to intensively stir even highly viscous substances and at the same time display their viscosity.

In addition, ULTRA-TURRAX® dispersers, temperature sensors, flow breakers and other accessories can be attached to the open ports of the reactor cover.

TECHNICAL DATA	LR-2.ST STARVISC 200
Min. volume (anchor stirrer)	500 ml
Max. volume	2000 ml
Max. working temperature	230 °C
Attainable vacuum	25 mbar
Max. viscosity	100 000 mPas
Speed min.	6 rpm
Max. torque at stirring shaft	200 Ncm
Materials in contact with medium	Stainless steel (AISI 316L) FFPM Borosilicate glass 3.3
Telescope stand stroke	620 – 1010 mm
Dimensions (W × H × D)	460 × 1240 × 430 mm



LR-2.ST STARVISC 200
EUR 12.658,00
Ident. No. 0020020603



WiCo LR 1000

LR 1000.1



LR 1000.10



LR 1000.20



LR 1000.41



LR 1000.64

Product	Description	Ident. No.	Price
ACCESSORIES LR 1000			
WiCo LR 1000	Wireless controller	0020007267	EUR 511,00
LR 1000.1	Reactor vessel, 1000 ml, FKM sealings, 4 connectors	0003602000	EUR 2.994,00
LR 1000.3	Reactor vessel, 1000 ml, FKM sealings, 6 connectors	0025001955	EUR 3.727,00
LR 1000.10	Anchor stirrer with PEEK scrapers	0004663100	EUR 374,00
LR 1000.11	Anchor stirrer, stainless steel	0004663000	EUR 220,00
LR 1000.20	Flow breaker / baffle, stainless steel	0004663200	EUR 292,00
LR 1000.41	Shaft receptacle	0004664300	EUR 411,00
LR 1000.61	Sensor receptacle	0004664400	EUR 376,00
LR 1000.62	Sensor receptacle GL 14	0020010508	EUR 322,00
LR 1000.64	pH electrode	0004663300	EUR 751,00
LR 1000.65	pH electrode receptacle	0004663400	EUR 636,00
LR 1000.70	Lid holder	0025003123	EUR 211,00
MV 1	Magnetic valve for cooling water control, max. 100 °C	0020003763	EUR 380,00
Holder MV 1	Holder for cooling water control valve	0020019816	EUR 169,00

Product	Description	Ident. No.	Price
ACCESSORIES LR-2.ST			
LR-2.SI	Safety stop	0003318300	EUR 835,00
LR 2000.10	Anchor stirrer with PEEK scraper	0002508400	EUR 1.256,00
LR 2000.11	Anchor stirrer, stainless steel	0002509500	EUR 585,00
LR 2000.20	Flow breaker / baffle, stn. steel	0002508500	EUR 574,00
LR 2.1	Glass reactor vessel, single-walled, 2000 ml	0003070000	EUR 722,00
LR 2000.1	Glass reactor vessel, double-walled, 2000 ml	0002508300	EUR 3.251,00
LR 2000.2	Glass reactor vessel, double-walled, bot. drain 2000 ml	0002509600	EUR 4.083,00
LR 2000.3	Stainless steel reactor vessel, double-walled, 2000 ml	0002509700	EUR 4.681,00
LR 2000.4	Stainless steel reactor vessel, double-walled, bot. drain, 2000 ml	0003064900	EUR 7.771,00



LR 2000.10



LR 2000.11



LR 2.1



LR 2000.1



LR 2000.2



LR 2000.3



LR 2000.4



HBR 4 control LR



T 25 digital LR

Product	Description	Ident. No.	Price
ACCESSORIES LR-2.ST			
LR 2000.40	Shaft receptacle	0002509200	EUR 510,00
LR 2000.60	Sensor receptacle	0002509300	EUR 460,00
LR 2000.64	pH process electrode	0020010075	EUR 1.067,00
LR 2000.65	pH measuring sensor receptacle	0003172600	EUR 753,00
LR-2.SP	Splinter shield	0003326400	EUR 385,00
LT 5.23	Hose adapter set	0002235000	EUR 118,00
LT 5.24	Hose adapter	0002578100	EUR 337,00
LT 5.25	Lock coupling set	0020000878	EUR 463,00
LT 5.26	Lock adapter set	0020000879	EUR 317,00
LT 5.27	Hose adapter set	0020000880	EUR 463,00
H 68.55	Temp. sensor, stn. steel, Ø 8 mm	0025001479	EUR 245,00
HBR 4 control LR	Heating bath, 4 l	0010001849	EUR 3.710,00
PT 1000.61	Temperature sensor, Ø 6 mm	0020009881	EUR 233,00
ACCESSORIES LABORATORY REACTORS			
T 25 digital LR	Disperser	0020008820	EUR 1.959,00
S 25 KV - 25 G	Dispersing element, Ø 25 mm	0002466900	EUR 1.999,00
S 25 KV - 25 F	Dispersing element, Ø 25 mm	0002404000	EUR 2.099,00
S 25 KV - 26 LR	Dissolver stirrer, high speed	0020015397	EUR 1.749,00
S 25 KD - LR - 18 G	Dispersing element, Ø 18 mm	0025007071	EUR 1.234,00

magic PLANT basic

Price on request
Ident. No. 0020001186

The ideal small laboratory plant for perfect mixing and homogenizing of liquid to pasty products.



magic PLANT inline

Price on request
Ident. No. U107703

Effective dispersing and homogenizing. In connection with the IKA magic LAB, the magic PLANT is specially adapted to the requirements of batch plants.



magic PLANT powder

Price on request
Ident. No. U107159

Efficient but gentle mixing and drying of all free flowing solids, including products with different bulk densities and particle sizes.



The IKA magic PLANT is an ideal laboratory scale process plant. This system is used for batch-wise mixing, homogenizing, emulsifying, in addition to forming sample suspensions for capacities of up to 2 liters. Whether it is involved with the

manufacturing of liquids, pastes or powders – the magic PLANT delivers, enabling a seamless transition from product development to production.

TECHNICAL DATA	MAGIC PLANT BASIC	MAGIC PLANT INLINE	MAGIC PLANT POWDER
Max. admissible temperature	150 °C	80 / 120 °C	150 °C
Working pressure range	-1 to 2,5 bar (5 bar*)	-0,5 to 2,5 bar	-1 to 2,5 bar (5 bar*)
Useful volume	1 – 2 l	0,5 – 2 l	0,5 – 1,5 l
Stirring tool	Anchor and propeller	Anchor	Spiral
Speed range	0 – 2000 rpm (Propeller, Dissolver) 0 – 350 rpm (Anchor, Spiral)	0 – 2000 rpm (Propeller, Dissolver) 0 – 350 rpm (Anchor, Spiral)	0 – 350 rpm (Spiral)

* with optional safety valve

Algaemaster 10 control

EUR 29.664,00
Ident. No. 0020009577

ALGAEMASTER 10 CONTROL

/// Growing algae made easy

Algae are becoming increasingly interesting for different industries. The IKA Algaemaster 10 control is a fully autonomous photo bioreactor that provides researchers with the equipment necessary for producing mass densities of sensitive microalgae.



Min. usable volume: 6 l
Max. usable volume: 10 l

TECHNICAL DATA	ALGAEMASTER 10 CONTROL
Useable volume	6000 – 10 000 ml
Viscosity max.	100 mPas
Speed range	10 – 100 rpm
Temperature measurement resolution	0,1 K
pH measuring range	0 – 13 pH
Accuracy of pH measurement	0,1 pH
pH measurement resolution	0,01 pH
Cooling medium temperature	4 – 60 °C
Speed deviation	±5 rpm
Speed display	TFT
Dimensions (W x H x D)	800 x 1000 x 600 mm
Weight	46 kg

- > Ocean water resistant and completely autoclavable lid and vessel
- > Metal-free components for sensitive bioactive materials
- > Material touching the product: borosilicate glass, PTFE, Ultem®
- > Computerized control of lighting, temperature, stirring, pH and dosing of liquid or gas
- > Customizable lid with nine receptacles
- > Effortless data collection via USB drive
- > Attractive cost / performance ratio

Advanced software with an innovative visual approach to lab automation. labworldsoft® is a multi-purpose software program for measuring, controlling and regulating laboratory devices. It can network up to 64 devices simultaneously via one PC, thus making the automation of your laboratory experiments and processes much more easy and efficient. It does not only integrate IKA laboratory devices but also supports devices from other manufacturers.

LABWORLDISOFT® 6

/// One software, unlimited possibilities



Manufacturers with interface devices compatible to labworldsoft®

labworldsoft® 6 Starter

EUR 4.017,00
Ident. No. 0020019397

labworldsoft® 6 Pro

EUR 9.167,00
Ident. No. 0020017366

labworldsoft® 6 Starter Update

EUR 803,00
Ident. No. 0020019398

labworldsoft® 6 Starter Upgrade

EUR 5.150,00
Ident. No. 0020019399

labworldsoft® 6 Pro Update

EUR 1.833,00
Ident. No. 0020018014

labworldsoft® 6 Pro + 5 Years Support

EUR 16.499,00
Ident. No. 0020022767



C 6040 Calwin

EUR 2.004,00
Ident. No. 0004040500

CalWin represents the newest generation of professional software for IKA calorimeters. It offers numerous functions for device control and monitoring as well as for evaluating results.



Expert Key 100 eco



Expert Key 100 pro



ETH SER 4

Product	Description	Ident. No.	Price
Expert Key 100 eco	Data collection system for laboratories	0020005486	EUR 5.200,00
Expert Key 100 pro	Data collection system for industries	0020005485	EUR 5.612,00
Multi power switch	Switchable multiple connection plug board	0020003454	EUR 77,00
MV 1 power plug	Cooling water valve with power plug	0010001655	EUR 462,00
RV 10 A 1	Adapter valve for Expert Key	0020004314	EUR 105,00
PT 100.1 A 1	Adapter LEMO for Expert Key	0020004315	EUR 70,00
PT 1000 A 1	Adapter DIN 6 for Expert Key	0020004316	EUR 72,00
PT 100.10 A 1	Adapter DIN 5 for Expert Key	0020004317	EUR 27,50
PC 1.1	Cable, L 3 m	0002616700	EUR 33,50
PC 1.5	Cable, L 2,5 m	0002756000	EUR 37,00
PC 2.1	Cable, L 5 m	0002700700	EUR 14,40
USB 3.0 EXT 10	USB 3.0 extension cable, L 10 m	0020021255	EUR 123,00
DTM 12.10	Data cable, L 2,5 m, 9 pins (F)	0003127800	EUR 309,00
PC 1.2	Adapter, 25 pins	0002616800	EUR 54,50
PC 1.4	Adapter, 9 pins (F), 15 pins (M)	0002755900	EUR 71,00
PC 2.2	Adapter, 9 pins (F), 25 pins (M)	0002753200	EUR 54,50
PCI 8.2	Plug-in card, 25 pins	0008017500	EUR 1.164,00
USB SER 4	USB-serial converter 4 ports	0020003456	EUR 329,00
USB SER 8	USB-serial converter 8 ports	0020018480	EUR 566,00
USB SER 16	USB-serial converter 16 ports	0020018736	EUR 978,00
USB Hub 2.0 4	USB hub 2.0 4 ports	0020021256	EUR 82,00
USB Hub 2.0 7	USB hub 2.0 7 ports	0020021257	EUR 154,00
ETH SER 4	Ethernet-serial converter 4 ports	0003192000	EUR 1.634,00
ETH SER 8	Ethernet-serial converter 8 ports	0020021350	EUR 1.287,00
ETH SER 16	Ethernet-serial converter 16 ports	0020021351	EUR 1.957,00

IKA oxygen bomb calorimeters are the market leaders when it comes to determining the calorific values of liquid and solid samples. The selection of IKA oxygen bomb calorimeters are optimally geared towards various different demands. Functionality, safety and longevity were the main goals in the development of IKA's oxygen bomb calorimeters.

C 6000

/// An evolution in calorimetry

The champion of modern calorimetry has been developed even further. The new C 6000 has an intuitive touch screen with unique user guidance. The high level of automation simplifies everyday work and enables high sample throughput. The strictest adherence to standards gives rise to the most accurate repeatable results in the world and guarantees the desired assurance.



C 1 Package 1/10

Price on request
Ident. No. 0010002412

C 1 Package 2/10

Price on request
Ident. No. 0010002413

C 1 Package 3/10

Price on request
Ident. No. 0010002414

C 1 Package 1/12

Price on request
Ident. No. 0010002415

C 1 Package 2/12

Price on request
Ident. No. 0010002416

C 1 Package 3/12

Price on request
Ident. No. 0010002417



C 200

Price on request
Ident. No. 0008802500

C 200 h

Price on request
Ident. No. 0008803700

C 200 auto

Price on request
Ident. No. 0010002379

C 200 h auto

Price on request
Ident. No. 0010002387

TECHNICAL DATA	C 1	C 200 C 200 H
Maximum energy input	40 000 J / 9560 cal	40 000 J / 9560 cal
Resolution of the temperature sensor	0,0001 K	0,0001 K
Power ON-time	100 %	100 %
Oxygen operating pressure max.	40 bar	40 bar
Measuring modes / Measurements per hour	Static jacket (Regnault Pfaundler) 4	Isoperibol 3, Dynamic 6 Manual 3, Time-controlled 4
Start temperature settings	2 possible settings: 22 °C or 30 °C	18 – 25 °C
Reproducibility (1g benzoic acid NBS39i)	Static jacket (Regnault Pfaundler) 0,15 % RSD	Isoperibol 0,1 % RSD Dynamic 0,1 % RSD Manual (Isoperibol) 0,1 % RSD Time-controlled 0,1 % RSD
Number of decomposition vessels per unit	up to 2	up to 4
Dimensions (W x H x D)	290 x 280 x 300 mm	400 x 400 x 400 mm

**C 6000 isoperibol
Package 1/10**Price on request
Ident. No. 0010004524**C 6000 isoperibol
Package 1/12**Price on request
Ident. No. 0010004525**C 6000 isoperibol
Package 2/10**Price on request
Ident. No. 0010004526**C 6000 isoperibol
Package 2/12**Price on request
Ident. No. 0010004527**C 6000 global standards
Package 1/10**Price on request
Ident. No. 0010004520**C 6000 global standards
Package 1/12**Price on request
Ident. No. 0010004521**C 6000 global standards
Package 2/10**Price on request
Ident. No. 0010004522**C 6000 global standards
Package 2/12**Price on request
Ident. No. 0010004523**TECHNICAL DATA**

TECHNICAL DATA	C 6000 ISOPERIBOL I GLOBAL STANDARDS
Maximum energy input	40 000 J / 9560 cal
Resolution of the temperature sensor	0,0001 K
Display	TFT with touch screen
Oxygen operating pressure max.	40 bar
Reproducibility (1g benzoic acid NBS39i)	Isoperibol 0,05% RSD Dynamic 0,15% RSD Adiabatic 0,05% RSD
Measuring modes	Isoperibol 22 / 25 / 30 °C Dynamic 22 / 25 / 30 °C Adiabatic 22 / 25 / 30 °C
Measurements per hour	Isoperibol 4 Dynamic 6 Adiabatic 5
Number of possible decomposition vessels per device	up to 4
Dimensions (W x H x D)	500 x 425 x 450 mm

AOD 1Price on request
Ident. No. 0008801300**C 7000 Set 1**Price on request
Ident. No. 0008800900**C 7000 Set 2**Price on request
Ident. No. 0008801400**TECHNICAL DATA**

TECHNICAL DATA	C 7000
Maximum energy input	30 000 J
Resolution of the temperature sensor	0,0001 K
Display	LED
Oxygen operating pressure max.	40 bar
Reproducibility (1g benzoic acid NBS39i)	0,2 % RSD
Measuring modes	Double dry (ISO 1928)
Working temperature max.	30 °C
Number of possible decomposition vessels per device	8
Dimensions (W x H x D)	310 x 395 x 490 mm

TECHNICAL DATA

TECHNICAL DATA	AOD
Decomposition time	3 min
Chamber volume	210 ml
Pressure max.	195 bar
Core temperature max.	1200 °C
Oxygen operating pressure max.	40 bar
Permissible ambient temperature	min. 5 °C max. 40 °C
Weight	12,5 kg
Dimensions (W x H x D)	400 x 480 x 260 mm
Power input	45 W



C 1.12



C 1.20



C 1.50

Product	Description	Ident. No.	Price
ACCESSORIES AND CONSUMABLES C 1			
C 1/10	Food add on Package for C 1	0010001917	EUR 4.425,00
C 1.20	Water heater	0004501000	EUR 1.156,00
C 1.10	Combustion chamber	0004500300	EUR 384,00
C 1.12	Combustion chamber, halogen resistant	0004500400	EUR 2.400,00
C 1.50	Dot matrix printer	0004500600	EUR 1.003,00
C 1.30	Venting station	0004500900	EUR 1.772,00
C 1.1012	Organizer	0004500700	EUR 156,00
C 1.101	Set of spare parts, approx. 1000 experiments	0004502200	EUR 298,00
C 1.121	Set of spare parts, approx. 1000 experiments	0004502300	EUR 611,00
C 1.103	Ignition wire, standard, Kanthal, 5 pcs.	0004579300	EUR 38,00
C 1.123	Ignition wire, platinum, 2 pcs.	0004500200	EUR 127,00

ACCESSORIES AND CONSUMABLES C 6000

C 6010	Decomposition vessel, standard	0003770000	EUR 2.749,00
C 6012	Decomposition vessel, halogen resistant	0004504000	EUR 5.190,00
C 6010.10	Combustion shield	0020007518	EUR 98,50
C 1.50	Dot matrix printer	0004500600	EUR 1.003,00
C 6030	Venting station	0004504100	EUR 2.088,00
C 60.1012	Organizer	0004504200	EUR 218,00
C 6000.10	Set of spare parts, approx. 1000 experiments	0004504300	EUR 859,00
C 6000.12	Set of spare parts, approx. 1000 experiments	0004504400	EUR 2.188,00
C 1.103	Ignition wire, standard, Kanthal, 5 pcs.	0004579300	EUR 38,00
C 1.123	Ignition wire, platinum, 2 pcs.	0004500200	EUR 127,00

ACCESSORIES ALL CALORIMETERS

C 27	Calorimeter preparation set	0004579700	EUR 103,00
C 29	Pressure gauge, oxygen	0000750200	EUR 1.019,00
C 21	Pelleting press	0001605300	EUR 2.923,00
C 5010.8	Crucible holder, small	0004579800	EUR 143,00
C 5010.5	Crucible holder, big	0003055900	EUR 174,00



C 21



C 200.RC



C 248

Product	Description	Ident. No.	Price
ACCESSORIES C 200			
C 200.RC	Set of hoses	0020010835	EUR 499,00
C 248	Oxygen station	0003520000	EUR 904,00
C 200.1	Measuring cup, 2000 ml	0003548900	EUR 39,00
C 200.2	Conversion kit for C 5012	0004028800	EUR 145,00

ACCESSORIES C 200, C 2000, C 5000

C 5010	Decomposition vessel, standard	0007114000	EUR 3.423,00
C 5012	Decomposition vessel, halogen resistant	0007215000	EUR 6.953,00
C 5030	Venting station	0007198000	EUR 2.516,00
C 5010.4	Attachment for combustible crucible C 14	0003016900	EUR 238,00
C 26	Prep stand	0008804000	EUR 178,00

ACCESSORIES C 2000, C 5000, C 6000

C 5020	Sample rack	0007145000	EUR 5.535,00
--------	-------------	------------	--------------

ACCESSORIES C 2000, C 5000, C 7000

C 5041.10	Connection cable	0003036000	EUR 43,00
-----------	------------------	------------	-----------

ACCESSORIES C 1, C 2000, C 6000

C 25	Pressure regulating valve	0003197200	EUR 330,00
------	---------------------------	------------	------------

ACCESSORIES C 7000

C 7000	Measurement cell	0003008000	On request
C 7010	Decomposition vessel, standard	0003015000	EUR 3.964,00
C 7012	Decomposition vessel, halogen resistant	0003017000	EUR 7.719,00
C 7002	Cooling system	0007011000	On request
C 48	Oxygen station	0001560000	EUR 2.418,00
C 7030	Venting station	0003013300	EUR 1.883,00
C 7010.8	Venting handle	0007095000	EUR 424,00
C 5010.4	Attachment for combustible crucible C 14	0003016900	EUR 238,00
C 5010.5	Crucible holder, big	0003055900	EUR 174,00



C 5020



C 48



C 7010.8



C 5010.4



C 5010.5

Product	Description	Ident. No.	Price
CONSUMABLES ALL CALORIMETERS			
C 6000.1	Water protect, 100 ml	0020014031	EUR 71,00
C 710.4	Cotton thread, cut to length, 500 pcs.	0001483700	EUR 32,50
C 710.8	Cotton thread, cut to length, thick, 500 pcs.	0004579900	EUR 32,50
C 4	Quartz dish	0001695500	EUR 24,50
C 5	Set of VA combustion crucibles, 25 pcs.	0001749500	EUR 124,00
C 6	Quartz dish, big	0000355100	EUR 35,00
C 710.2	Set of VA combustion crucibles, big, 25 pcs.	0001483500	EUR 191,00
C 9	Gelatine capsules, 100 pcs.	0000749900	EUR 33,50
C 10	Acetobutyrate capsules, 100 pcs.	0000750000	EUR 90,50
C 12	Combustion bags, 40 × 35 mm, 100 pcs.	0002201400	EUR 35,00
C 12 A	Combustion bags, 70 × 40 mm, 100 pcs.	0002201500	EUR 36,00
C 15	Parafilm strips	0003131100	EUR 43,00
C 16	Parafilm, 1000 × 50 mm	0003801100	EUR 50,00
C 17	Paraffin, liquid, 30 ml	0003801200	EUR 83,00
C 43	Benzoic acid, NIST 39j, 30 g	0000750600	EUR 551,00
C 723	Benzoic acid, blister package, 50 pcs.	0003243000	EUR 120,00
C 723 Big Pack	Benzoic acid, blister package, 450 pcs.	0003717400	EUR 757,00
AOD 1.11	Control standard oil for S, Cl, 50 ml	0003044000	EUR 264,00
CONSUMABLES C 200, C 2000, C 5000, C 7000			
C 5010.3	Ignition wire, spare, 5 pcs.	0007122800	EUR 47,00
C 5012.3	Ignition wire, spare, 5 pcs.	0002994900	EUR 133,00
C 14	Combustible crucibles, 100 pcs.	0007224500	EUR 89,00



C 710.4



C 5



C 4



C 10



C 9



C 15



C 12



C 43



C 17



AOD 1.11



C 723



C 5012.3



AOD 1.2



AOD 1.1



AOD 1.3



Product	Description	Ident. No.	Price
ACCESSORIES AOD 1			
AOD 1.1	Decomposition vessel	0003303000	EUR 5.532,00
AOD 1.2	External ignition unit	0003348000	EUR 1.299,00
AOD 1.3	Protection device	0003308000	EUR 2.181,00
AOD 1.13	Remote ignition head	0003348100	EUR 612,00
C 48	Oxygen station	0001560000	EUR 2.418,00
C 7030	Venting station	0003013300	EUR 1.883,00
C 21	Pelleting press	0001605300	EUR 2.923,00
C 29	Pressure gauge, oxygen	0000750200	EUR 1.019,00
C 5010.4	Attachment for combustible crucible C 14	0003016900	EUR 238,00
CONSUMABLES AOD 1			
C 4	Quartz dish	0001695500	EUR 24,50
C 9	Gelatine capsules, 100 pcs.	0000749900	EUR 33,50
C 10	Acetobutyrate capsules, 100 pcs.	0000750000	EUR 90,50
C 12	Combustion bags, 40 × 35 mm, 100 pcs.	0002201400	EUR 35,00
C 12 A	Combustion bags, 70 × 40 mm, 100 pcs.	0002201500	EUR 36,00
C 14	Combustible crucibles, 100 pcs.	0007224500	EUR 89,00
C 15	Parafilm strips	0003131100	EUR 43,00
C 5012.3	Ignition wire, platinum, 2 pcs.	0002994900	EUR 133,00
C 710.4	Cotton thread, cut to length, 500 pcs.	0001483700	EUR 32,50
AOD 1.11	Control standard oil for S, Cl, 50 ml	0003044000	EUR 264,00
C 723	Benzoic acid, blister package, 50 pcs.	0003243000	EUR 120,00
C 723 Big Pack	Benzoic acid, blister package, 450 pcs.	0003717400	EUR 757,00

C 6040 Calvin

EUR 2.004,00

Ident. No. 0004040500*

* Connection cable C 5041.10 and USB / RS 232 adapter are included with the delivery



R 200

R 270



RH 5

LABLIFT m

Product	Description	Ident. No.	Price
FIXING ELEMENTS			
H 44	Boss head clamp	0002437700	EUR 29,00
R 200	Clamp for T 10 basic and R 104	0003372000	EUR 30,50
R 182	Boss head clamp, clamping range Ø 6 – 16 mm	0002657700	EUR 79,00
R 270	Boss head clamp, clamping range Ø 25 – 36 mm	0002657800	EUR 104,00
R 271	Boss head clamp, clamping range Ø 34 mm	0002664000	EUR 168,00
R 350	Universal clamp	0001752900	EUR 99,00
RH 3	Strap clamp for stand Ø 8 – 16 mm	0003008600	EUR 259,00
RH 5	Strap clamp for stand Ø 25 – 36 mm	0003159000	EUR 319,00
LABLIFT m	Manual scissor lift	0004022400	EUR 269,00

STANDS

R 104	Stand for T 10 basic, H 370 mm	0003386000	EUR 147,00
R 1825	Plate stand, H 560 mm	0003160000	EUR 254,00
R 1826	Plate stand, H 800 mm	0003160100	EUR 279,00
R 1827	Plate stand, H 1000 mm	0003160200	EUR 299,00
R 2722	H-stand, 1010 mm	0001412000	EUR 655,00
R 2723	Telescopic stand, H 620 – 1010 mm	0001412100	EUR 1.214,00
T 653	Telescopic stand, H 1200 mm	0001608000	EUR 1.599,00
R 474	Telescopic stand, H 1200 mm	0001643000	EUR 1.599,00
R 472	Floor stand, H 2020 mm	0000738700	EUR 3.399,00
R 2850	Floor stand, H 1900 mm	0020002900	EUR 2.499,00
R 6547 H	Floor stand, hydraulic	0020018378	EUR 7.099,00
R 6547.1	Container clamping device for R 6547 H / E floor stand	0020018383	EUR 3.099,00



R 6547 H



R 104

R 1825

R 2722

R 2723

R 474

R 2850



ALMEMO 2490



PT 100.23

Product	Description	Ident. No.	Price
ELECTRONIC ACCESSORIES			
ALMEMO 2490	Temperature measuring instrument	0004709300	EUR 1.601,00
R 2850.SI	Safety stop	0020010623	EUR 1.131,00
IKA [scale]	Stand with weighing function	0025004318	EUR 719,00
R 6547 E 400V	Floor stand, electrohydraulics	0020018384	EUR 12.099,00
ACCESSORIES ALMEMO			
ALMEMO USB cable	USB cable	0004709400	EUR 325,00
PT 100.23	Temp. sensor, stn. steel	0003122100	EUR 263,00
PT 100.24	Temp. sensor, stn. steel, coated	0003122200	EUR 269,00
PT 100.25	Temp. sensor, stn. steel	0003122300	EUR 216,00

IKA [SCALE]**/// The first stand scale of its kind**

A stand with an integrated scale and data interface: only available from IKA. The IKA [scale] provides increased comfort and safety for your laboratory applications. For example, your stirrer can hang on the stable support rod. The quantities of samples to be added are weighed immediately and continuously documented during the stirring process.

SAMPLE WEIGHT OF UP TO 6 KG

The intelligent stand scale has a weighing range of up to 6 kg with a resolution of 1 g. It is therefore particularly suitable for the direct and controlled addition of sample material while stirring.

CLEAR DISPLAY

Working with the clear and modern LCD display is very user-friendly. All information, whether measurement values, calibration steps or status messages, is shown clearly.

STABLE SET-UP PLATE

The solid die cast zinc housing provides stability and robustness.

BLUETOOTH CONNECTION

The weight of the sample measured can directly be transferred to a suitable device (e.g. IKA MINI-/ MICROSTAR series) and shown on its display.



Patented:
The IKA [scale] is
unique in the market!



C-MAG HS 7 Package



T 18 digital Package

Product	Description	Ident. No.	Price
MAGNETIC STIRRER PACKAGE			
C-MAG HS 7 Package			
C-MAG HS 7	Magnetic stirrer with heating, ceramic plate	0003581200	
ETS-D5	Electronic contact thermometer	0003378000	
H 38	Holding rod	0003547700	
H 44	Boss head clamp	0002437700	
H 16 V	Support rod	0001545100	
DISPERSER PACKAGE			
T 18 digital Package			
T 18 digital	Disperser	0003720000	
S 18 N - 19 G	Dispersing tool	L004640	



ICC basic eco 8



ICC control pro 9

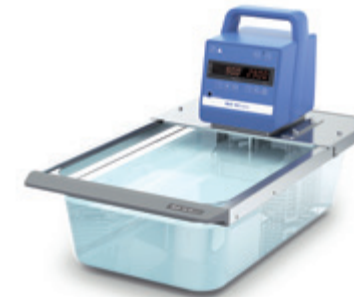

ICC basic eco 18



ICC control pro 20

Product	Description	Ident. No.	Price
HEATING BATH CIRCULATORS			
ICC basic eco 8 Package*			
ICC basic	Compact immersion circulator	0004134400	
IB eco 8	Bath vessel, plastic	0004248100	
ICC control eco 8 Package*			
ICC control	Compact immersion circulator	0004136600	
IB eco 8	Bath vessel, plastic	0004248100	
ICC basic pro 9 Package*			
ICC basic	Compact immersion circulator	0004134400	
IB pro 9	Bath vessel, stainless steel	0004248500	
ICC control pro 9 Package*			
ICC control	Compact immersion circulator	0004136600	
IB pro 9	Bath vessel, stainless steel	0004248500	
ICC basic eco 18 Package*			
ICC basic	Compact immersion circulator	0004134400	
IB eco 18	Bath vessel, plastic	0004248200	
ICC control eco 18 Package*			
ICC control	Compact immersion circulator	0004136600	
IB eco 18	Bath vessel, plastic	0004248200	
ICC basic pro 12 Package*			
ICC basic	Compact immersion circulator	0004134400	
IB pro 12	Bath vessel, stainless steel	0004577500	
ICC control pro 12 Package*			
ICC control	Compact immersion circulator	0004136600	
IB pro 12	Bath vessel, stainless steel	0004577500	
ICC basic pro 20 Package*			
ICC basic	Compact immersion circulator	0004134400	
IB pro 20	Bath vessel, stainless steel	0004248600	
ICC control pro 20 Package*			
ICC control	Compact immersion circulator	0004136600	
IB pro 20	Bath vessel, stainless steel	0004248600	

* Bath bridge included in delivery



ICC basic eco 8 c

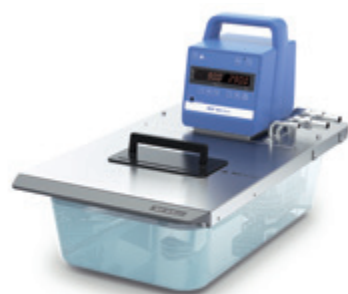

ICC basic eco 8 c



ICC basic pro 12 c



ICC control pro 20 c

Product	Description	Ident. No.	Price
COMBINED HEATING BATH CIRCULATORS			
ICC basic eco 8 c Package*			
ICC basic	Compact immersion circulator	0004134400	
IB eco 8	Bath vessel, plastic	0004248100	
ICC control eco 8 c Package*			
ICC control	Compact immersion circulator	0004136600	
IB eco 8	Bath vessel, plastic	0004248100	
ICC basic pro 9 c Package*			
ICC basic	Compact immersion circulator	0004134400	
IB pro 9	Bath vessel, stainless steel	0004248500	
ICC control pro 9 c Package*			
ICC control	Compact immersion circulator	0004136600	
IB pro 9	Bath vessel, stainless steel	0004248500	
ICC basic eco 18 c Package*			
ICC basic	Compact immersion circulator	0004134400	
IB eco 18	Bath vessel, plastic	0004248200	
ICC control eco 18 c Package*			
ICC control	Compact immersion circulator	0004136600	
IB eco 18	Bath vessel, plastic	0004248200	
ICC basic pro 12 c Package*			
ICC basic	Compact immersion circulator	0004134400	
IB pro 12	Bath vessel, stainless steel	0004577500	
ICC control pro 12 c Package*			
ICC control	Compact immersion circulator	0004136600	
IB pro 12	Bath vessel, stainless steel	0004577500	
ICC basic pro 20 c Package*			
ICC basic	Compact immersion circulator	0004134400	
IB pro 20	Bath vessel, stainless steel	0004248600	
ICC control pro 20 c Package*			
ICC control	Compact immersion circulator	0004136600	
IB pro 20	Bath vessel, stainless steel	0004248600	

* Bath bridge, cover, pump connection set and cooling coil are included in delivery



ICC control IB R RO 15 eco

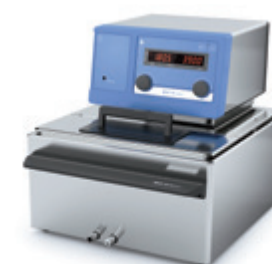

ICC control pro 9

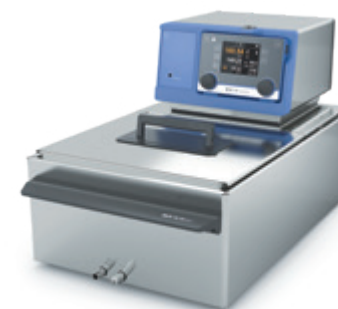

IC control pro 20 c

Product	Description	Ident. No.	Price
PACKAGES WITH MAGNETIC STIRRER			
ICC basic IB R RO 15 eco Package			
ICC basic	Compact immersion circulator	0004134400	
IB R RO 15 eco	Bath vessel, plastic	0020006341	
BL.ICC	Bath bridge	0020003078	
RO 15	Multiposition magnetic stirrer	0003692500	
ICC control IB R RO 15 eco Package			
ICC control	Compact immersion circulator	0004136600	
IB R RO 15 eco	Bath vessel, plastic	0020006341	
BL.ICC	Bath bridge	0020003078	
RO 15	Multiposition magnetic stirrer	0003692500	
IMMERSION CIRCULATOR IC PACKAGES			
IC basic pro 12 c Package*			
IC basic	Immersion circulator	0003861000	
IB pro 12	Bath vessel, stainless steel	0004577500	
CM.IC	Cover	0004577600	
IC control pro 12 c Package*			
IC control	Immersion circulator	0003863000	
IB pro 12	Bath vessel, stainless steel	0004577500	
CM.IC	Cover	0004577600	
IC basic pro 20 c Package*			
IC basic	Immersion circulator	0003861000	
IB pro 20	Bath vessel, stainless steel	0004248600	
CM.IC	Cover	0004577600	
IC control pro 20 c Package*			
IC control	Immersion circulator	0003863000	
IB pro 20	Bath vessel, stainless steel	0004248600	
CM.IC	Cover	0004577600	

* Bath bridge and cooling coil are included in delivery



RV 3 V-C



RV 8 V-C

Product	Description	Ident. No.	Price
ROTARY EVAPORATOR PACKAGES			
RV 3 V Package			
RV 3	Drive	0020015793	
HB eco	Heating bath	0025004726	
RV 10.1	Set of glassware, vertical	0003655300	
RV 10.70	Vapor tube, NS 29/32	0003812200	
RV 3 V-C Package			
RV 3	Drive	0020015793	
HB eco	Heating bath	0025004726	
RV 10.10	Set of glassware, vertical, coated	0003755400	
RV 10.70	Vapor tube, NS 29/32	0003812200	
RV 3 FLEX Package			
RV 3	Drive	0020015793	
HB eco	Heating bath	0025004726	
RV 05.10	Balljoint clamp	0000736600	
RV 10.70	Vapor tube, NS 29/32	0003812200	
RV 10.88	Clamp, NS 29	0003683300	
RV 8 V Package			
RV 8	Drive	0025002822	
HB digital	Heating bath	0020004009	
RV 10.1	Set of glassware, vertical	0003655300	
RV 10.70	Vapor tube, NS 29/32	0003812200	
RV 8 V-C Package			
RV 8	Drive	0025002822	
HB digital	Heating bath	0020004009	
RV 10.10	Set of glassware, vertical, coated	0003755400	
RV 10.70	Vapor tube, NS 29/32	0003812200	
RV 8 FLEX Package			
RV 8	Drive	0025002822	
HB digital	Heating bath	0020004009	
RV 05.10	Balljoint clamp	0000736600	
RV 10.70	Vapor tube, NS 29/32	0003812200	
RV 10.88	Clamp, NS 29	0003683300	



RV 10 digital V-C

Product	Description	Ident. No.	Price
ROTARY EVAPORATOR PACKAGES			
RV 10 digital V Package			
RV 10 digital	Drive	0003550099	
HB digital	Heating bath	0020004009	
RV 10.1	Set of glassware, vertical	0003655300	
RV 10.70	Vapor tube, NS 29/32	0003812200	
RV 10 digital V-C Package			
RV 10 digital	Drive	0003550099	
HB digital	Heating bath	0020004009	
RV 10.10	Set of glassware, vertical, coated	0003755400	
RV 10.70	Vapor tube, NS 29/32	0003812200	
RV 10 digital FLEX Package			
RV 10 digital	Drive	0003550099	
HB digital	Heating bath	0020004009	
RV 05.10	Balljoint clamp	0000736600	
RV 10.70	Vapor tube, NS 29/32	0003812200	
RV 10.88	Clamp, NS 29	0003683300	

Product	Description	Ident. No.	Price
ROTARY EVAPORATOR PACKAGES			
RV 10 auto V Package			
RV 10 auto	Drive	0020003919	
HB digital	Heating bath	0020004009	
RV 10.1	Set of glassware, vertical	0003655300	
RV 10.70	Vapor tube, NS 29/32	0003812200	
RV 10.4002	Magnetic valve laboratory vacuum	0003880300	
RV 10 auto V-C Package			
RV 10 auto	Drive	0020003919	
HB digital	Heating bath	0020004009	
RV 10.10	Set of glassware, vertical, coated	0003755400	
RV 10.70	Vapor tube, NS 29/32	0003812200	
RV 10.4002	Magnetic valve laboratory vacuum	0003880300	
RV 10 auto FLEX Package			
RV 10 auto	Drive	0020003919	
HB digital	Heating bath	0020004009	
RV 05.10	Balljoint clamp	0000736600	
RV 10.70	Vapor tube, NS 29/32	0003812200	
RV 10.88	Clamp, NS 29	0003683300	
RV 10.4002	Magnetic valve laboratory vacuum	0003880300	



RV 10 auto V-C

Product	Description	Ident. No.	Price
ROTARY EVAPORATOR PACKAGES			
RV 10 auto pro V Package			
RV 10 auto	Drive	0020003919	
VACSTAR digital	Pump with analog connection	0020016236	
HB digital	Heating bath	0020004009	
RV 10.1	Set of glassware, vertical	0003655300	
RV 10.70	Vapor tube, NS 29/32	0003812200	
RV 10 auto pro V-C Package			
RV 10 auto	Drive	0020003919	
VACSTAR digital	Pump with analog connection	0020016236	
HB digital	Heating bath	0020004009	
RV 10.10	Set of glassware, vertical, coated	0003755400	
RV 10.70	Vapor tube, NS 29/32	0003812200	
RV 10 auto pro FLEX Package			
RV 10 auto	Drive	0020003919	
VACSTAR digital	Pump with analog connection	0020016236	
HB digital	Heating bath	0020004009	
RV 05.10	Balljoint clamp	0000736600	
RV 10.70	Vapor tube, NS 29/32	0003812200	
RV 10.88	Clamp, NS 29	0003683300	



RV 10 auto pro V-C



C 1



C 200 auto

Product	Description	Ident. No.	Price
CALORIMETER PACKAGES			
C 1 Package 1/10 Package			
C 1	Calorimeter	0020010860	
C 1.10	Combustion chamber	0004500300	
RC 2 basic	Recirculating chiller	0004171000	
C 1 Package 2/10 Package			
C 1	Calorimeter	0020010860	
C 1.10	Combustion chamber	0004500300	
C 1 Package 3/10 Package			
C 1	Calorimeter	0020010860	
C 1.10	Combustion chamber	0004500300	
C 1.20	Water heater	0004501000	
C 1 Package 1/12 Package			
C 1	Calorimeter	0020010860	
C 1.12	Combustion chamber, halogen resistant	0004500400	
RC 2 basic	Recirculating chiller	0004171000	
C 1 Package 2/12 Package			
C 1	Calorimeter	0020010860	
C 1.12	Combustion chamber, halogen resistant	0004500400	
C 1 Package 3/12 Package			
C 1	Calorimeter	0020010860	
C 1.12	Combustion chamber, halogen resistant	0004500400	
C 1.20	Water heater	0004501000	
C 200 auto Package			
C 200	Measurement cell	0003385000	
RC 2 basic	Recirculating chiller	0004171000	
C 200.RC	Set of hoses	0020010835	
C 5010	Decomposition vessel	0007114000	
C 248	Oxygen filling station	0003520000	
C 200 h auto Package			
C 200	Measurement cell	0003385000	
RC 2 basic	Recirculating chiller	0004171000	
C 200.RC	Set of hoses	0020010835	
C 5012	Decomposition vessel, halogen resistant	0007215000	
C 200.2	Conversion kit	0004028800	
C 248	Oxygen filling station	0003520000	



C 6000

Product	Description	Ident. No.	Price
CALORIMETER PACKAGES			
C 6000 global standards Package 1/10			
C 6000 global standards	Measurement cell	0020005930	
C 6010	Decomposition vessel, standard	0003770000	
RC 2 basic	Recirculating chiller	0004171000	
C 6000 global standards Package 1/12			
C 6000 global standards	Measurement cell	0020005930	
C 6012	Decomposition vessel, halogen resistant	0004504000	
RC 2 basic	Recirculating chiller	0004171000	
C 6000 global standards Package 2/10			
C 6000 global standards	Measurement cell	0020005930	
C 6010	Decomposition vessel, standard	0003770000	
C 6000 global standards Package 2/12			
C 6000 global standards	Measurement cell	0020005930	
C 6012	Decomposition vessel, halogen resistant	0004504000	
C 6000 isoperibol Package 1/10			
C 6000 isoperibol	Measurement cell	0020005940	
C 6010	Decomposition vessel, standard	0003770000	
RC 2 basic	Recirculating chiller	0004171000	
C 6000 isoperibol Package 1/12			
C 6000 isoperibol	Measurement cell	0020005940	
C 6012	Decomposition vessel, halogen resistant	0004504000	
RC 2 basic	Recirculating chiller	0004171000	
C 6000 isoperibol Package 2/10			
C 6000 isoperibol	Measurement cell	0020005940	
C 6010	Decomposition vessel, standard	0003770000	
C 6000 isoperibol Package 2/12			
C 6000 isoperibol	Measurement cell	0004025000	
C 6012	Decomposition vessel, halogen resistant	0004504000	



C 7000

Product	Description	Ident. No.	Price
CALORIMETER PACKAGES			
C 7000 Set 1 Package			
C 7000	Measurement cell	0003008000	On request
C 7010	Decomposition vessel, standard	0003015000	
C 7002	Cooling system	0007011000	
C 48	Oxygen station	0001560000	
C 7000 Set 2 Package			
C 7000	Measurement cell	0003008000	On request
C 7012	Decomposition vessel, halogen resistant	0003017000	
C 7002	Cooling system	0007011000	
C 48	Oxygen station	0001560000	

VISCOMETER PACKAGES*

ROTAVISC lo-vi Complete Package	0025000310	EUR 2.858,00
ROTAVISC me-vi Complete Package	0025000311	EUR 2.858,00
ROTAVISC hi-vi I Complete Package	0025000312	EUR 2.858,00
ROTAVISC hi-vi II Complete Package	0025000313	EUR 2.858,00
ROTAVISC lo-vi Advanced Package	0025000320	EUR 3.573,00
labworldsoft® 6	0020019397	
ROTAVISC me-vi Advanced Package	0025000321	EUR 3.573,00
labworldsoft® 6	0020019397	
ROTAVISC hi-vi I Advanced Package	0025000322	EUR 3.573,00
labworldsoft® 6	0020019397	
ROTAVISC hi-vi II Advanced Package	0025000323	EUR 3.573,00
labworldsoft® 6	0020019397	



ROTAVISC me-vi Complete

* ROTAVISC packages include:
SP 1-4 (lo-vi) / SP 7-12 (me-vi, hi-vi I, hi-vi II), protective bracket,
temperature sensor, quick connector, hook connector, ROTASTAND stand



ElectraSyn 2.0

Product	Description	Ident. No.	Price
ELECTROCHEMISTRY PACKAGES			
ElectraSyn 2.0 Package			
ElectraSyn 2.0	Base unit	0020001549	EUR 2.389,00
Vial holder		0020014424	
Vial	10 ml	0020014424	
Stir plate		0040001991	
Electrode Graphite	2 pcs.	0040002574	
ElectraSyn 2.0 pro Package			
ElectraSyn 2.0	Base unit	0020001549	EUR 2.808,00
Vial holder		0020014424	
Vial	10 ml	0020014424	
Stir plate		0040001991	
Electrode Graphite	2 pcs.	0040002574	
CV glassy carbon	Electrodes	0040002066	
CV Platinum	Electrodes	0040002569	
Ag / AgCl	Reference electrode	0040003172	
Screening System Package (6 divided cells)			
Reaction block		0020015936	EUR 11.639,00
Electrolysis cells		0040001849	
IKA Plate (RCT digital)	Magnetic stirrer, including PT 1000 temperature sensor	0025004601	
Electrode graphite	16 pcs.	0040001850	
Screening System Package (8 undivided cells)			
Reaction block		0020015943	EUR 10.712,00
Electrolysis cells		0040001849	
IKA Plate (RCT digital)	Magnetic stirrer, including PT 1000 temperature sensor	0025004601	
Electrode graphite	16 pcs.	0040001850	



Screening System



SERVICE PLUS FROM IKA

/// We adapt to your requirements

/// PRODUCT MODIFICATIONS

If you can't find exactly what you are looking for, get in touch with the IKA Customizing Center. Our team will check how we can fulfill your product requirements using customized solutions. For further information and examples of implemented product change requests, please contact sales@ika.de.

/// APPLICATION SUPPORT

You can test all of the laboratory equipment yourself at the IKA Application Center. Our experts will analyze your processes and work with you to decide how to optimize your application.

Application Center

Our Application Center shows the latest laboratory equipment over an area of 400 m².

Equipment tests

The Application Team provides support with customized testing of equipment and processes.

Sample analysis and application recommendation

We also process samples sent in to us and give you a report on the results with application recommendations within a period of two working days.



/// WORLDWIDE SERVICE

Your decision to use a product from IKA is also a decision to opt for the excellent technical service provided by IKA in your region. Our team is at your disposal worldwide for service questions. Replacement parts for your IKA laboratory equipment are guaranteed for 10 years.



/// IKA WARRANTIES

IKA offers generous free warranty extensions if you register your product at www.ika.com/register directly after purchase. You can normally benefit from a year of additional services (2 + 1). With some equipment we even guarantee several years of warranty extensions:

- > Rotary evaporators and KS 4000 incubation shakers: warranty extension for three years (2 + 3).
- > Viscometers, RCT digital, C-Mag HS 7 control and MICROSTAR / MINISTAR digital / control range: extension by a full eight years (2 + 8)!
- > For pipettes and calorimeters: a one year warranty plus an additional year following registration (1 + 1).

The free warranty extension can be acquired in just a few clicks at www.ika.com/register.

Any questions? Our service team is at your personal disposal:
00 8000 4524357 (00 8000 IKAHELP)

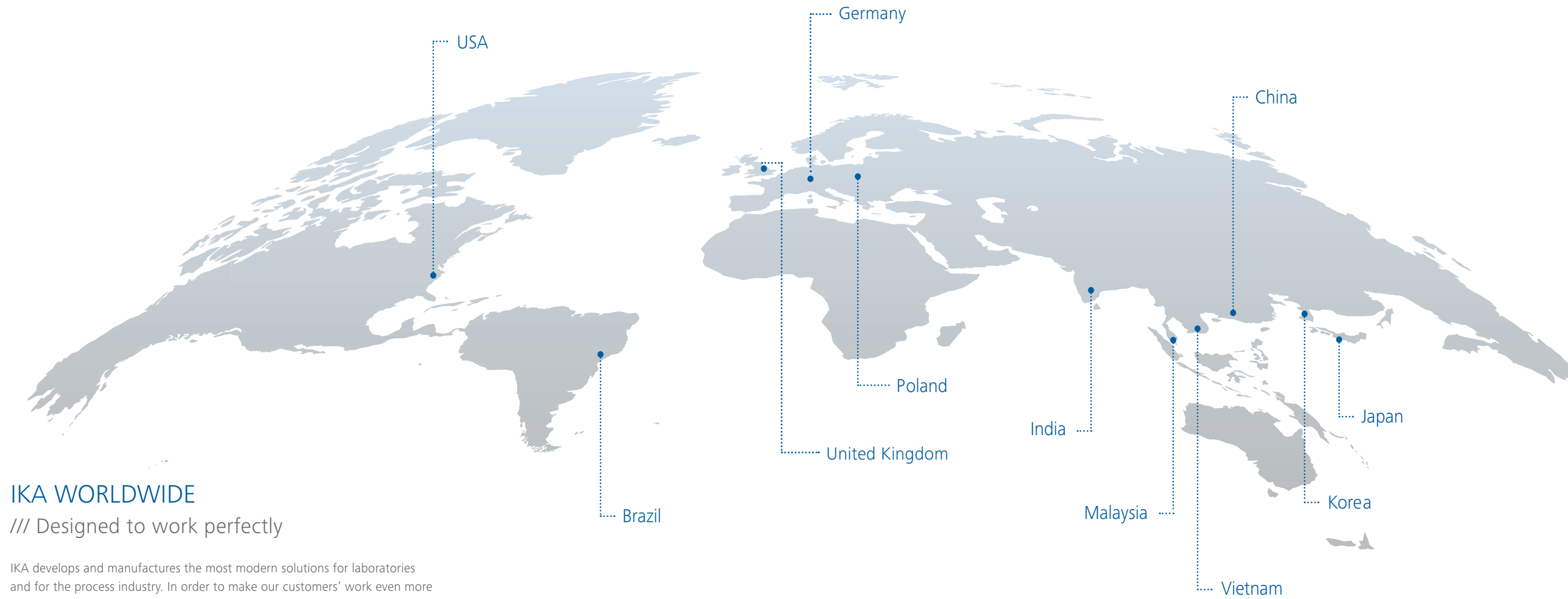

IKA WORLDWIDE

/// Designed to work perfectly

IKA develops and manufactures the most modern solutions for laboratories and for the process industry. In order to make our customers' work even more successful, we combine the latest technology with innovative design and we look far into the future. Our products are prepared accordingly for integration in your digital laboratory.

We are a responsibility-aware family company, whilst also being a global player. Over 900 employees make a contribution each and every day to extending our world-leading market position in laboratory, analytical and processing technology.

In our headquarters in Staufen, we have been developing our products and technologies with the collaboration of application experts from the fields of science and industry for over 70 years. From there, they are sold to more than 160 countries. Excellent local service is also provided by our own subsidiaries in the USA, China, Japan, India, Brazil, Korea, Vietnam, the United Kingdom and Poland.



designed for scientists

EN

IKA-Werke GmbH & Co. KG

Janke & Kunkel-Straße 10, 79219 Staufen, Germany
Phone: +49 7633 831-0, Fax: +49 7633 831-98
eMail: sales@ika.de

/// WORLDWIDE

USA

IKA Works, Inc.
Phone: +1 910 452-7059
eMail: sales@ika.net

KOREA

IKA Korea Ltd.
Phone: +82 2 2136 6800
eMail: info@ika.kr

BRAZIL

IKA Brazil
Phone: +55 19 3772-9600
eMail: sales@ika.net.br

MALAYSIA

IKA Works (Asia) Sdn Bhd
Phone: +60 3 6099-5666
eMail: sales.lab@ika.my

CHINA

IKA Works Guangzhou
Phone: +86 20 8222 6771
eMail: info@ika.cn

POLAND

IKA Poland Sp. z o.o.
Phone: +48 22 201 99 79
eMail: sales.poland@ika.com

JAPAN

IKA Japan K.K.
Phone: +81 6 6730 6781
eMail: info_japan@ika.ne.jp

INDIA

IKA India Private Limited
Phone: +91 80 26253 900
eMail: info@ika.in

UNITED KINGDOM

IKA England LTD.
Phone: +44 1865 986 162
eMail: sales.english@ika.com

VIETNAM

IKA Vietnam Company Limited
Phone: +84 28 38202142
eMail: sales.lab-vietnam@ika.com

Subject to technical changes and alteration of prices.
Prices are valid until October 31st, 2020
and exclude taxes and other sales related fees.



www.ika.com



IKAworlwide // #lookattheblue